



PRODUCT BINDER 2018

CONTENTS

ESSENTIAL INFORMATION FOR PRODUCT SELECTION AND PRICING

HARDWARE TABLE OF CONTENTS

HAND FORGED IRON HARDWARE

IRON PATINAS

IRON LEVER & KNOB OPTIONS

IRON ENTRY DOOR HARDWARE

IRON INTERIOR DOOR HARDWARE

IRON ACCESSORIES

IRON KITCHEN & BATH HARDWARE

SOLID BRONZE HARDWARE

BRONZE PATINAS

BRONZE LEVER & KNOB OPTIONS

BRONZE ENTRY DOOR HARDWARE

BRONZE INTERIOR DOOR HARDWARE

BRONZE ACCESSORIES

BRONZE KITCHEN & BATH HARDWARE



PRODUCT BINDER

EFFECTIVE JANUARY 2018

All rights reserved. Rev 0416

3205A Mercantile Court, Santa Fe NM 87507 USA

Tel 505.983.2644 Fax 505.820.2941 sales@hardwarerenaissance.com www.hardwarerenaissance.com



ESSENTIAL INFORMATION

Our goal is to make it easy for you to specify & order our products. Some key points:

- We manufacture **two complete, separate lines** of door hardware & accessories: Genuine Hand forged Iron & Solid Cast Bronze.
- PRODUCT CODES BEGINNING WITH "H" ARE FOR HAND-FORGED IRON
PRODUCT CODES BEGINNING WITH "B" ARE FOR BRONZE
- There are DIFFERENT patinas (finishes) for hand forged iron and for bronze. Due to different materials and processes, we cannot offer an iron patina on a bronze product or vice versa.
- Products are divided into entry hardware, interior hardware (passage, privacy, dummy sets, escutcheon & lever options, door & appliance pulls, pocket door hardware etc.), accessories (surface bolts, straps, door knockers, screen door & window hardware, etc.), kitchen & bath hardware, and hospitality (keyless entries).
- FOR ARCHITECTS & DESIGN PROFESSIONALS: since we sell only through authorized dealers listed on our website, you will need to contact a dealer for pricing (including trade discounts which are discretionary to dealers).
- PRICING DEPENDS UPON ESCUTCHEON CHOICE. Price includes your choice of any lever or knob. Levers or knobs shown in the binder are what best match the design.
- Price includes your choice of any of our patinas.
- Standard door thickness is 1.75". Unless specified, our hardware will NOT work with doors thinner than 1.75". Upcharges may apply, so please inquire about options and pricing for thinner doors.
- Upcharges apply for doors thicker than 1.75". See Page 1 of the price list for details.
- Standard lead times are 8 weeks or less from receipt of order. Expedited lead time of 4-6 weeks is possible for **many** items with an upcharge - inquire for details.
- EVERY DOOR HARDWARE ORDER NEEDS PRODUCT CODE, FUNCTION, HANDING, DOOR THICKNESS, BACKSET, & PATINA.
- We welcome custom work inquiries. Please contact us with your drawings & requirements, and we will quote you the price & lead time (which varies with the degree of complexity). Custom work in solid bronze requires new pattern-making, which results in higher costs & even longer lead times, as compared to custom work in hand forged iron (since the latter is completely hand made by our master blacksmiths).

We are continuously adding new products, so DO check our website often!

We hope you like our distinctive designs & innovative patinas. Our products are also engineered for superior performance, which is why we back them with the best warranty in the business. We do believe that our hardware is Like no Other™.

DEALERS: EMAIL ORDERS TO sales@hardwarerenaissance.com



MASTER TABLE OF CONTENTS

	<u>SECTION</u>
HAND FORGED IRON PATINAS	A
HAND FORGED IRON ENTRY DOOR HARDWARE (INCLUDES LEVER/KNOB OPTIONS)	1
HAND FORGED IRON INTERIOR DOOR HARDWARE (INCLUDES LEVER/KNOB OPTIONS)	2
HAND FORGED IRON ACCESSORIES	3
HAND FORGED IRON KITCHEN & BATH HARDWARE	4
HAND FORGED IRON HOSPITALITY KEYLESS ENTRIES	5
SOLID BRONZE PATINAS	B
SOLID BRONZE ENTRY DOOR HARDWARE (INCLUDES LEVER/KNOB OPTIONS)	6
SOLID BRONZE INTERIOR DOOR HARDWARE (INCLUDES LEVER/KNOB OPTIONS)	7
SOLID BRONZE ACCESSORIES	8
SOLID BRONZE KITCHEN & BATH HARDWARE	9
SOLID BRONZE HOSPITALITY KEYLESS ENTRIES	10



HAND FORGED IRON HARDWARE

All rights reserved. Rev 1014

3205A Mercantile Court, Santa Fe NM 87507 USA

Tel 505.983.2644 Fax 505.820.2941 sales@hardwarerenaissance.com www.hardwarerenaissance.com



HAND FORGED IRON PATINAS

HARDWARE PRICE INCLUDES CHOICE OF ANY OF THE FOLLOWING HAND APPLIED PATINAS:

PATINA NAME	PATINA CODE
Hot Wax:	HW
Antique Rose:	AR
Antique Bronze:	AB
Rust Highlights:	RH
French Red:	FF
Old Pawn Silver:	OS
Satin Nickel:	SN
Antique Copper:	AC

IMPORTANT NOTE ABOUT OUR IRON PATINAS:

Our Iron hardware is NOT RUST-PROOF. We provide an authentic wax coating only. We cannot guarantee against rust. Maintenance instructions are included with each order. All orders will need a rust-waiver signed by the dealer confirming this understanding. The patinas which hold up best against rust and which are easier to maintain are Hot Wax and Antique Rose. The plated finishes (OS, SN, AC) are likely to rust sooner and are more difficult to maintain.

All patinas are hand applied and will vary slightly from patina samples or display samples. This is due to aging of samples, and natural variations in patina which occur depending upon surface texture of the iron, temperature and humidity while applying the patina. This is considered to be a key part of the beauty and uniqueness of the hand forged iron product and not a defect.

All our patinas are living finishes and will age gracefully over time. How quickly they will age depends upon the conditions of use and maintenance.



CONTENTS

This section contains all types of sets for entry or other exterior doors.

IRON LEVER & KNOB OPTIONS	Page L1-L2
Thumbblatch w/ Strike-bar Latch Mortise Entry sets	Page 1-1 / 1-2
Thumbblatch w/ Strike-bar Latch Tubular Entry sets	Page 1-3
Thumbblatch w/ Lever or Knob Entry sets	Page 1-4 / 1-6
Thumbblatch w/ Thumbblatch Entry sets	Page 1-7 / 1-8
Fixed Grip Deadbolt Entry sets	Page 1-9 / 1-10
Lever or Knob Entry sets	Page 1-11 / 1-12
Lever or Knob Sectional Deadbolt Entry sets	Page 1-13 / 1-14
Deadbolts only	Page 1-15
Strike-bar Latch Entry sets	Page 1-16 / 1-17
Multipoint Hardware	Page 1-18 / 1-23
Sliding Door Hardware	Page 1-24 / 1-26
Lift & Slide Hardware	Page 1-27

DOOR HANDING GUIDE:

Door Handing is determined by standing at the outside of the door while facing the door. The side of the hinges determines door handing.

Regular In-swing Doors



Out-swing Doors





HAND FORGED IRON LEVERS & KNOBS

THESE ARE OUR STANDARD LEVER & KNOB OPTIONS. PRICE INCLUDES CHOICE OF ANY OF THESE LEVERS OR KNOBS. **PRICE IS DETERMINED BY ESCUTCHEON CHOICE.**



HL101 Verona



HL102 Soho



HL103 Casa California



HL105 East-West



HL107 Neha

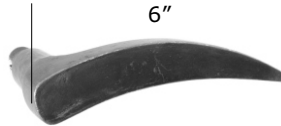

HL108 Fleetwood



HL109 Milan

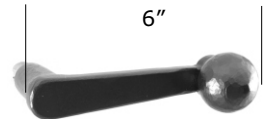

HL111 Ball



HL112 Spoon



HL113 Scrolled

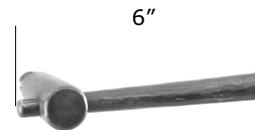

HL116 East-West II



HL131 Accent



HL132 Manhattan

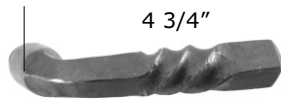

HL135 Toscana



HL136 Capri



HL138 Del Mar



HL139 Chelsea



HL140 Bay



HL141 Scottsdale



HL142 Taos

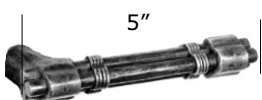

HL143 Trio



HL144 Fleur de Lis

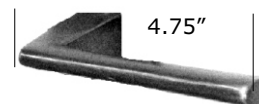

HL145 Salon

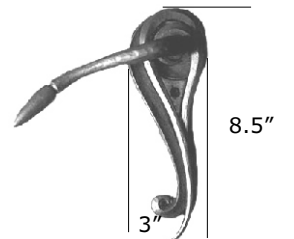

HL104 Art Nouveau

All rights reserved. Rev 1014



HAND FORGED IRON LEVERS & KNOBS

THESE ARE OUR STANDARD LEVER & KNOB OPTIONS. PRICE INCLUDES CHOICE OF ANY OF THESE LEVERS OR KNOBS. **PRICE IS DETERMINED BY ESCUTCHEON CHOICE.**

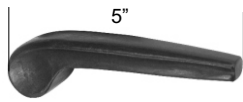

HL146 Mayfair



HL147 Taylor



HL148 Frisco



HL142 Carson



HL153 Loop

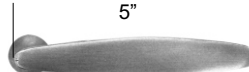

HL155 El Secreto



HL156 Monte Vista

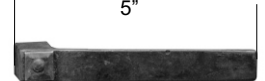

HL157 Cody



HL158 Avila



HL159 Sierra

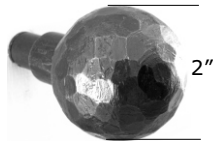

HK751 Forged Large

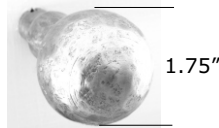

HK752 Forged Medium



HK753 Casa California

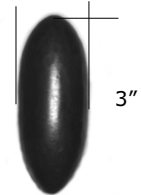

HK755 East-West

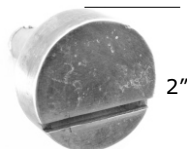

HK756 Sunrise

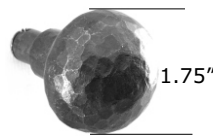

HK757 Mushroom

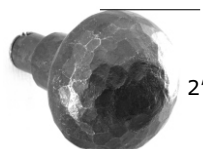

HK757L Mushroom Large



HK758 Martini

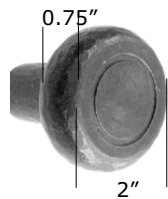

HK759 Hampton

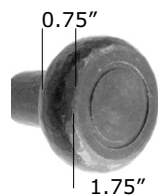

HK759M Hampton Medium

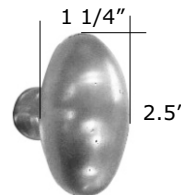

HK760 Bermuda



HP718 Ring Pull

All rights reserved. Rev 1014



HAND FORGED IRON ENTRY SETS

THUMBLATCH W/STRIKE-BAR LATCH MORTISE ENTRY SETS

WITH MORTISE DEADBOLT. FOR INSWING DOORS. EXTENDED BAR IS THE LATCH. MORTISE STRIKE INCLUDED.

INTERIOR STRIKE-BAR LATCH OPTIONS:



HH441 Normandy

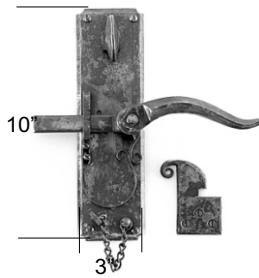

HS503 (shown w/HL101)

AVAILABLE WITH ANY LEVER

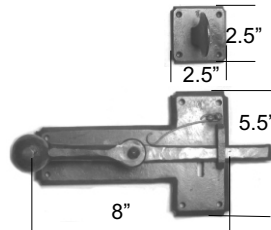

HS502 (shown w/HL111)

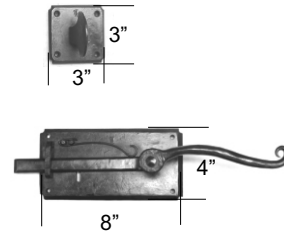

HS501S (shown w/HL113)

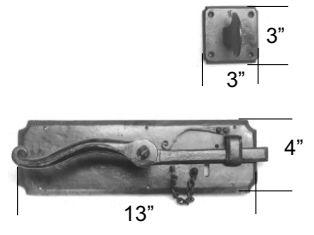

HS501 (shown w/HL113)

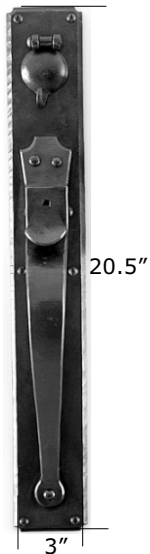

HH442 Seville

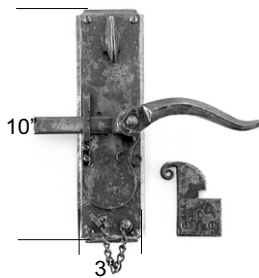

HS503 (shown w/HL101)

AVAILABLE WITH ANY LEVER

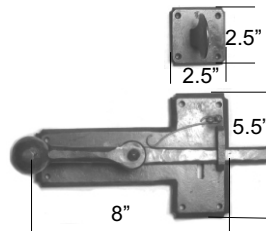

HS502 (shown w/HL111)

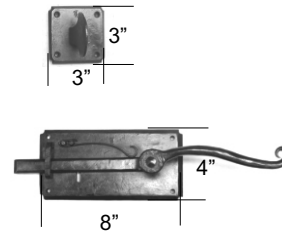

HS501S (shown w/HL113)

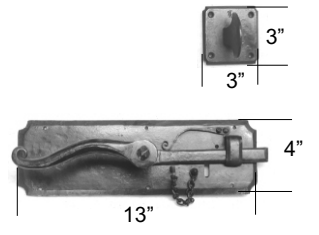

HS501 (shown w/HL113)

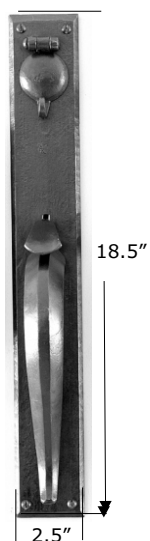

HH443 Verona

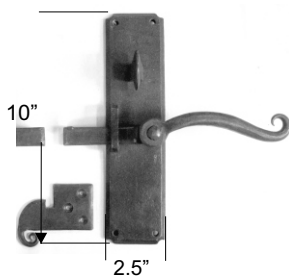

HS506NC (shown w/HL113)
OR HS506N w/square corners

AVAILABLE WITH ANY LEVER

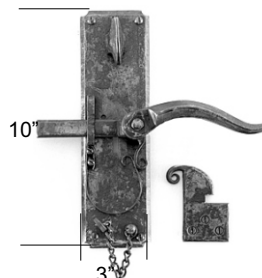

HS503 (shown w/HL101)



HAND FORGED IRON ENTRY SETS

THUMBLATCH W/STRIKE-BAR LATCH MORTISE ENTRY SETS

WITH MORTISE DEADBOLT. FOR INSWING DOORS. EXTENDED BAR IS THE LATCH. MORTISE STRIKE INCLUDED.

INTERIOR STRIKE-BAR LATCH OPTIONS:

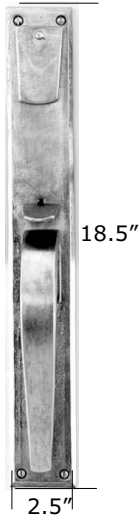

HH444 Manhattan

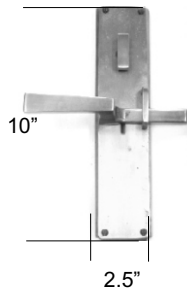

HS506N-HL132



HH454NC Orleans

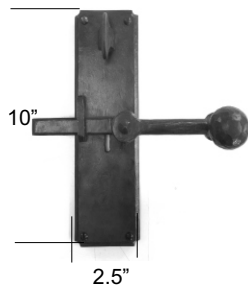

HS506NC (shown w/HL111)
AVAILABLE WITH ANY LEVER

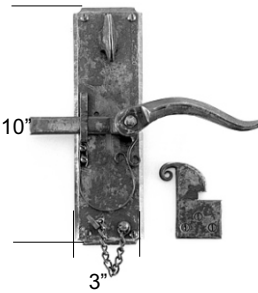

HS503 (shown w/HL101)



HH456 Sierra

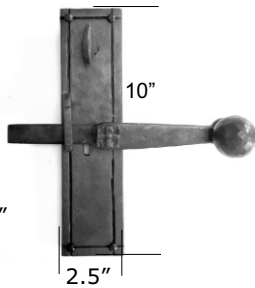

HS514-HL159



HAND FORGED IRON ENTRY SETS

THUMBLATCH W/STRIKE-BAR LATCH TUBULAR DEADBOLT ENTRY SETS

WITH TUBULAR DEADBOLT. FOR INSWING DOORS. EXTENDED BAR IS THE LATCH. MORTISE STRIKE INCLUDED.



HS503-EN-DB (shown w/HL101)
AVAILABLE WITH ANY LEVER

HH441 Normandy

ALSO AVAILABLE WITH HH443 OR HH454NC



WITH MORTISE LOCK. AVAILABLE WITH ANY LEVER OR KNOB ON INTERIOR SIDE.
(Can combine with interior escutcheons other than match ones shown)

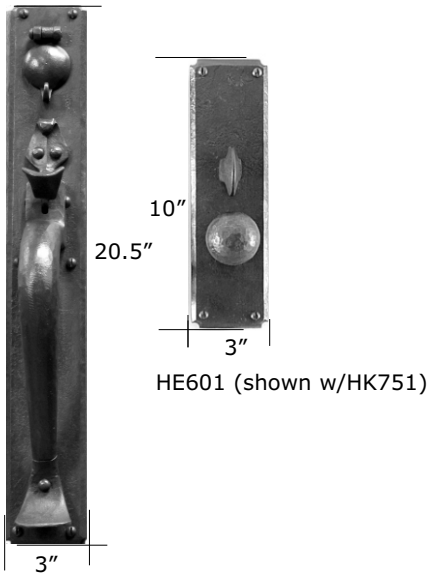

HH441 Normandy

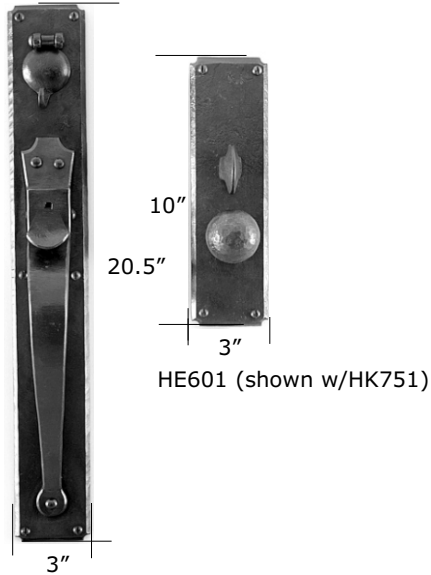

HH442 Seville

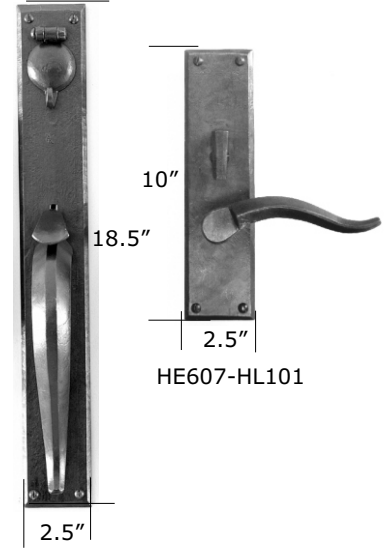

HH443 Verona

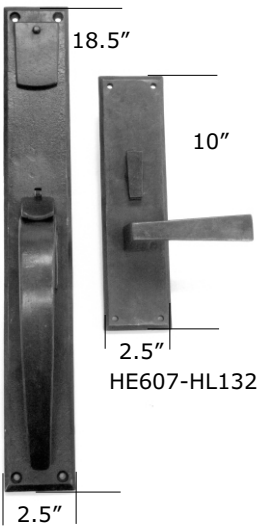

HH444 Manhattan

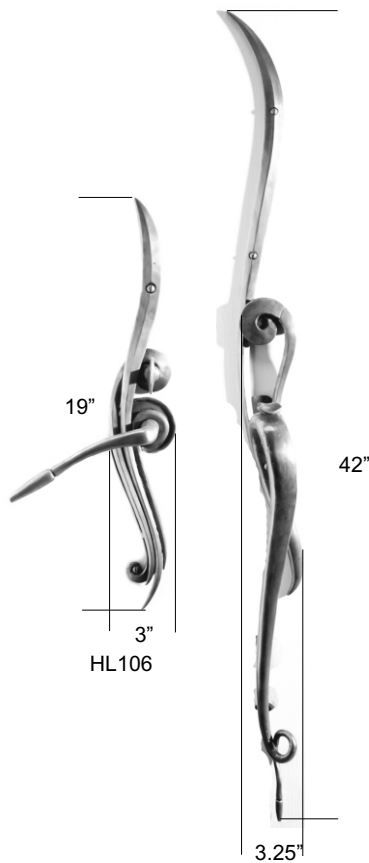

HH445 Louvre

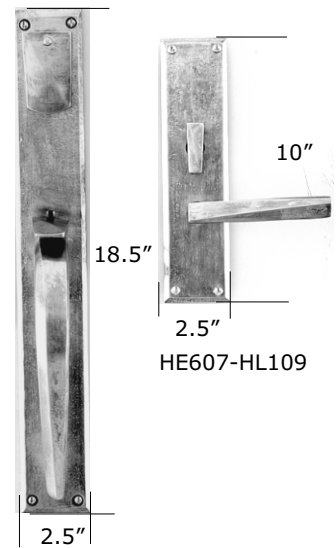

HH446 Milan



HAND FORGED IRON ENTRY SETS

THUMBLATCH W/LEVER OR KNOB ENTRY SETS

WITH MORTISE LOCK. AVAILABLE WITH ANY LEVER OR KNOB ON INTERIOR SIDE.
(Can combine with interior escutcheons other than match ones shown)

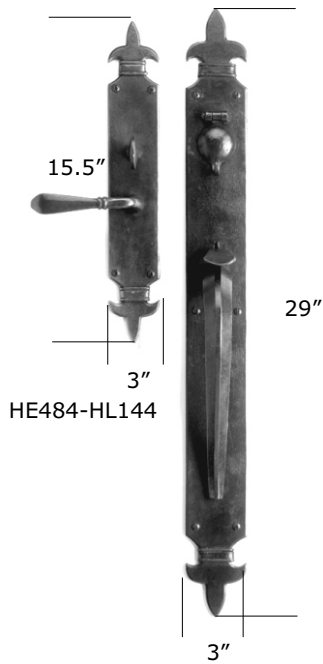

HE484-HL144

HH447 Fleur de Lis

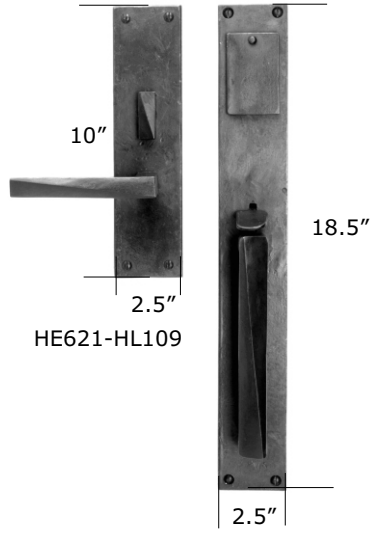

HE621-HL109

HH448 Milan II

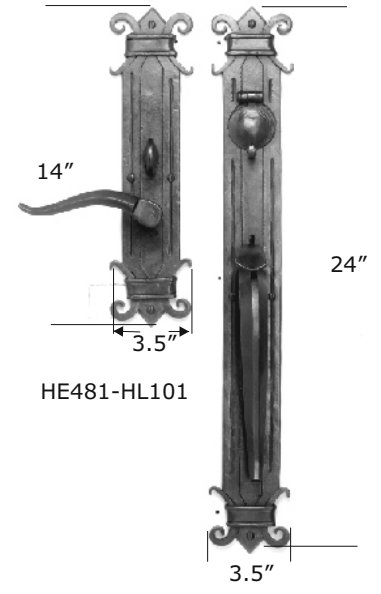

HE481-HL101

HH449 Chateau

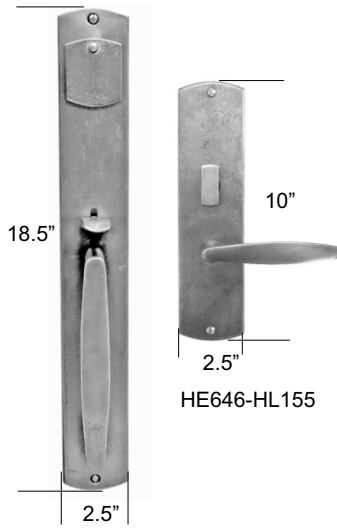

HE646-HL155

HH451 El Secreto

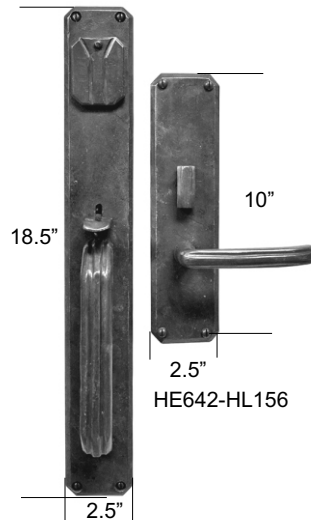

HE642-HL156

HH452 Monte Vista

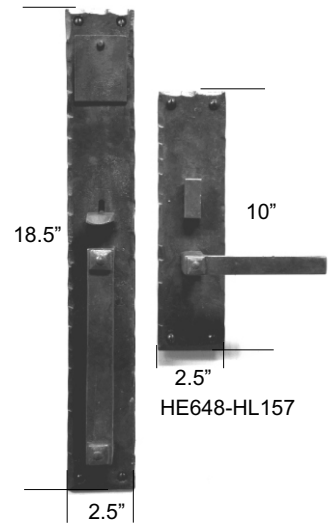

HE648-HL157

HH453 Cody

All rights reserved. Rev 1014



HAND FORGED IRON ENTRY SETS

THUMBLATCH W/LEVER OR KNOB ENTRY SETS

WITH MORTISE LOCK. AVAILABLE WITH ANY LEVER OR KNOB ON INTERIOR SIDE.
(Can combine with interior escutcheons other than match ones shown)

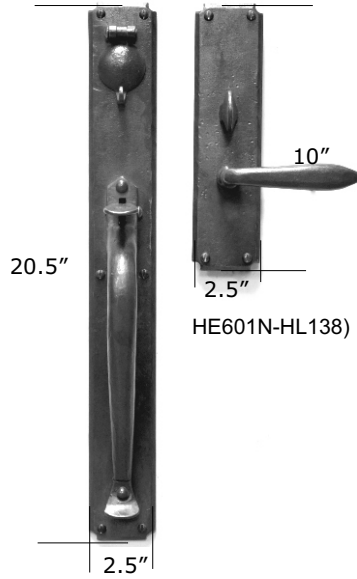

HE601N-HL138)

HH454NC Orleans
(Also available HH454 w/square corners)

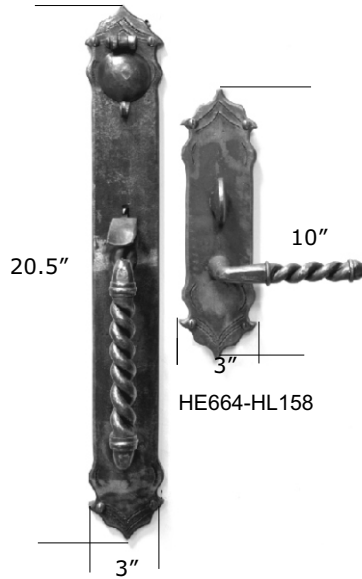

HE664-HL158

HH455 Avila

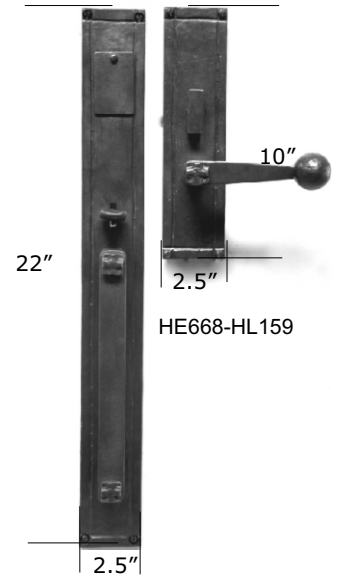

HE668-HL159

HH456 Sierra



WITH MORTISE LOCK

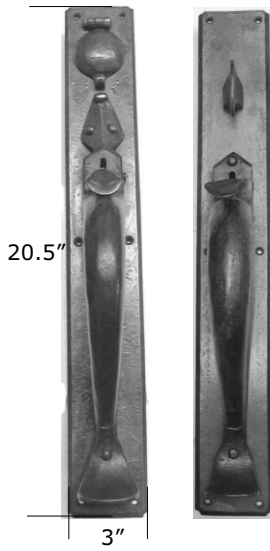

HH441 Normandy

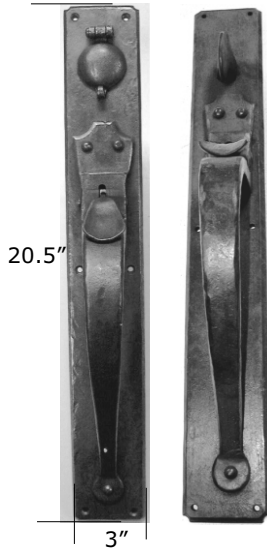

HH442 Seville

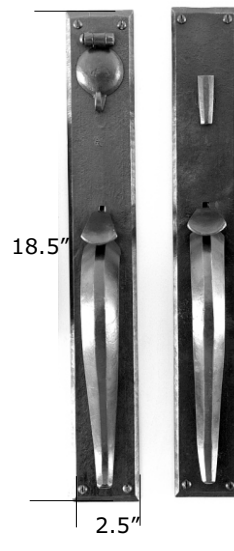

HH443 Verona

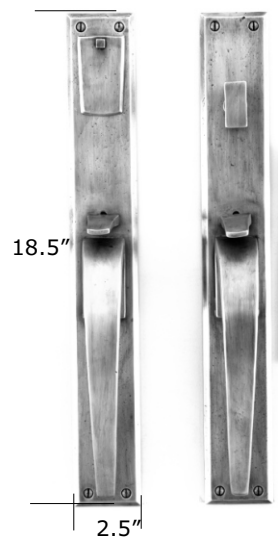

HH444 Manhattan

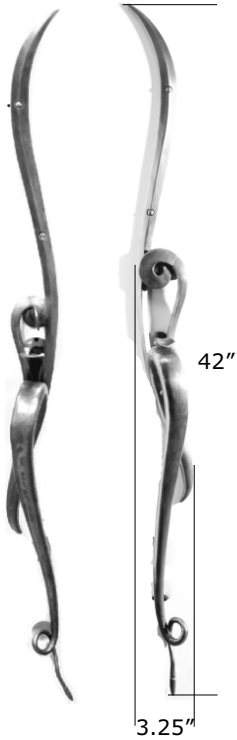

HH445 Louvre

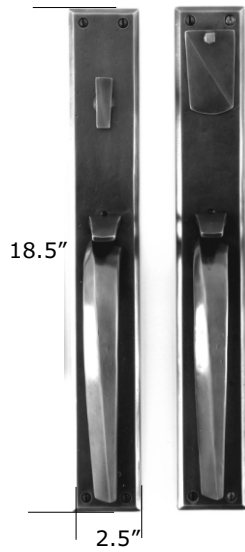

HH446 Milan

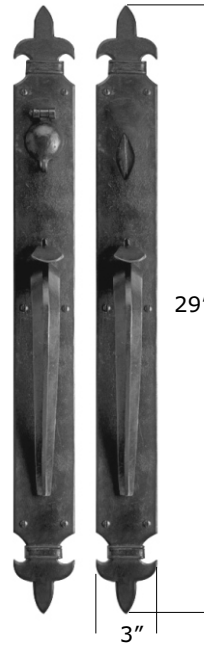

HH447 Fleur de Lis

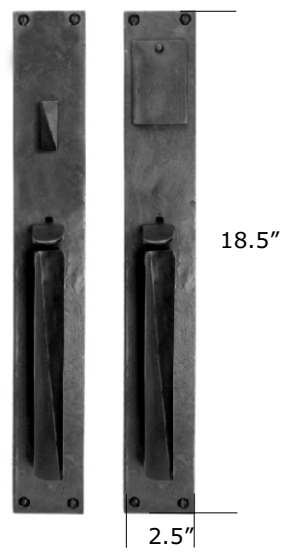

HH448 Milan II



WITH MORTISE LOCK

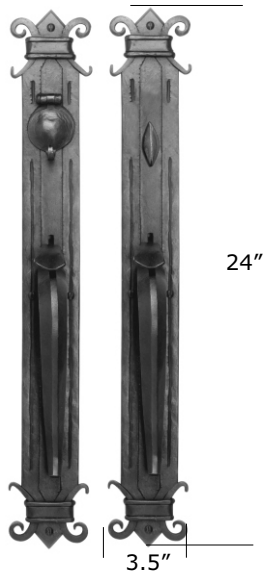

HH449 Chateau

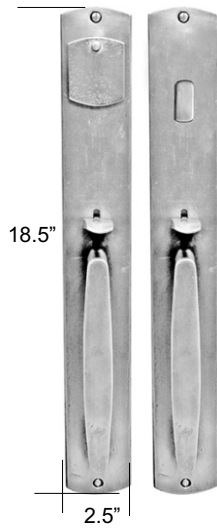

HH451 El Secreto

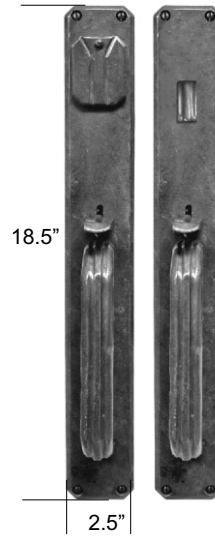

HH452 Monte Vista

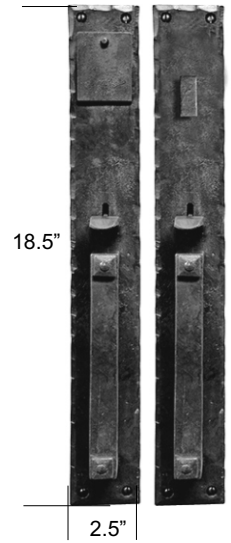

HH453 Cody

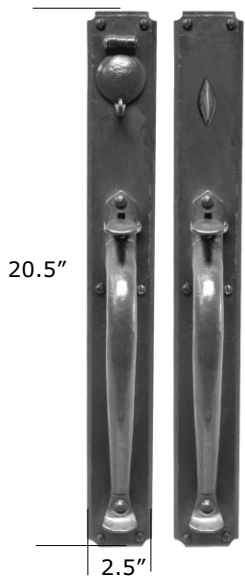

HH454NC Orleans
(OR HH454 w/square corners)

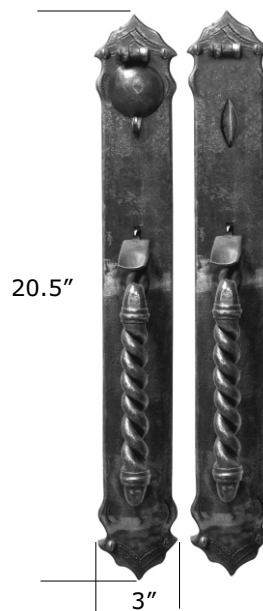

HH455 Avila

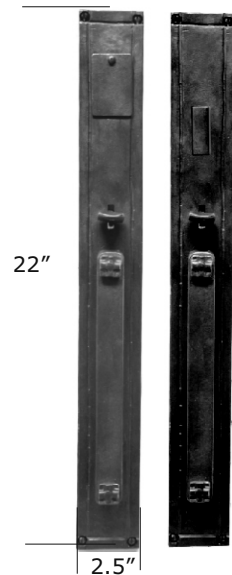

HH456 Sierra



FIXED GRIP SETS AVAILABLE WITH TUBULAR DEADBOLT (EN-DB) OR MORTISE DEADBOLT (EN-MD)



HP701L Fishtail Pull
(4" projection)

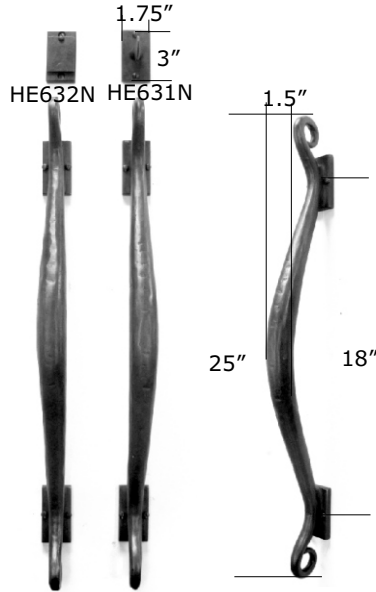

HP113 Scrolled Pull
(4" projection)

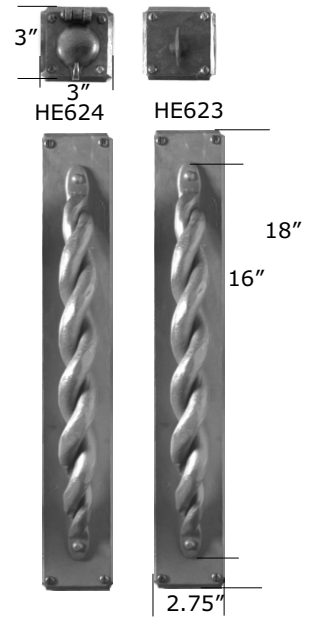

HP702 Rope Pull
(3.25" projection)

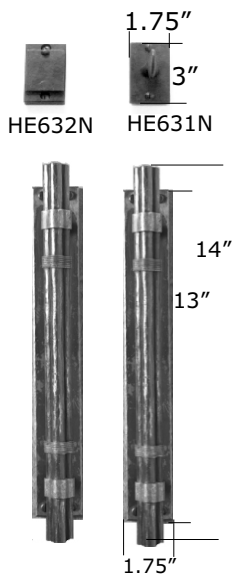

HP706 Trio Pull
(3.5" projection)

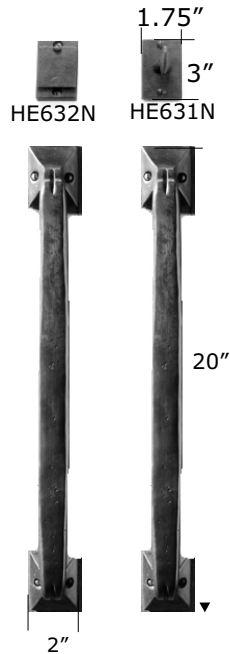

HP707L El Secreto Pull
(2.5" projection)

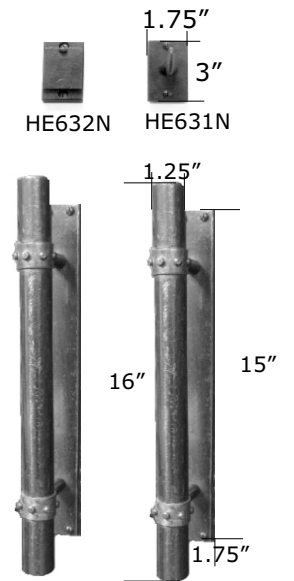

HP709 Galisteo Pull
(3.5" projection)

All rights reserved. Rev 1014



FIXED GRIP SETS AVAILABLE WITH TUBULAR DEADBOLT (EN-DB) OR MORTISE DEADBOLT (EN-MD)

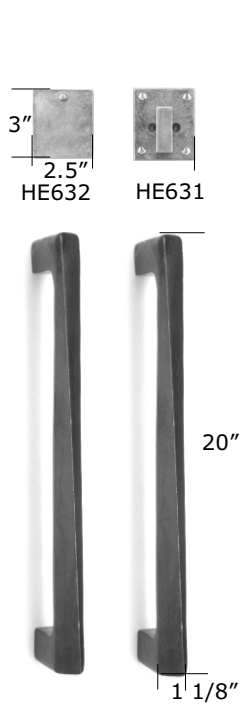

HP725L Milan Pull
(2" projection)

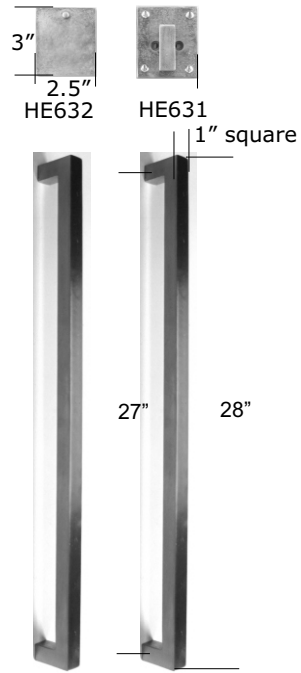

HP26L-28 Stockholm
(2.5" projection)

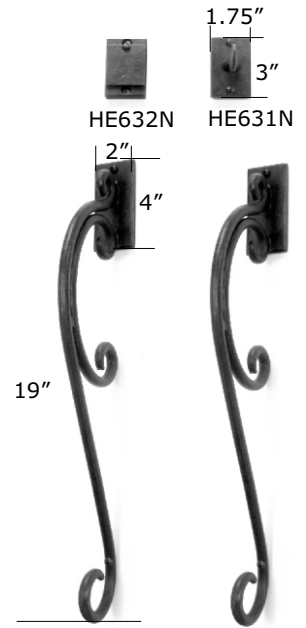

HP783 Balboa Pull
(4.5" projection)

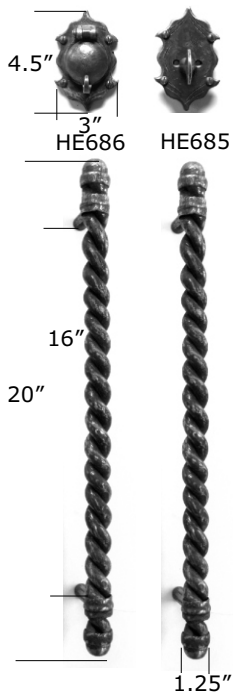

HP785 Avila Pull
(3.25" projection)

All rights reserved. Rev 1014



AVAILABLE WITH MORTISE LOCK (EN-ML) OR TUBULAR DEADBOLT (EN-DB). AVAILABLE WITH ANY LEVER OR KNOB.
(Tubular Deadbolt is made with 5.5" center-to-center standard)

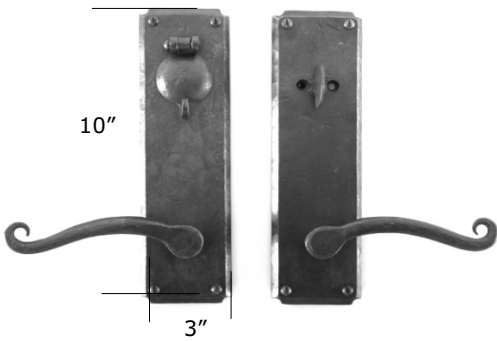

HE601 (shown w/ HL113 Lever)

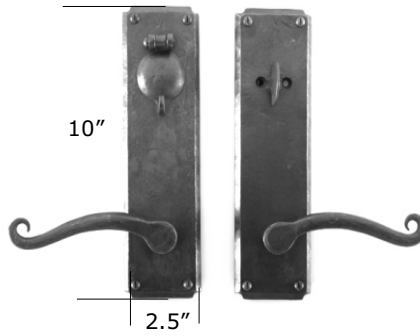

HE601N Notched Corner

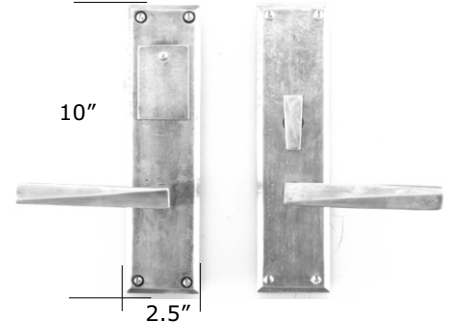

HE607 Beveled (shown w/HL109 Lever)

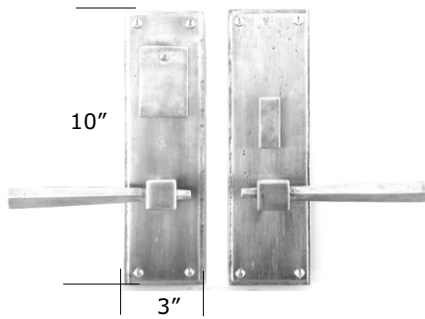

HE614 Step (shown w/HL105 Lever)

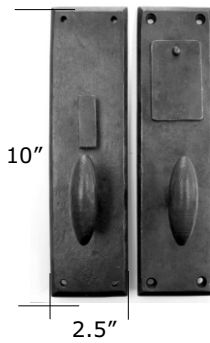

HE621 Straight Edge (shown w/HK756 Knob)

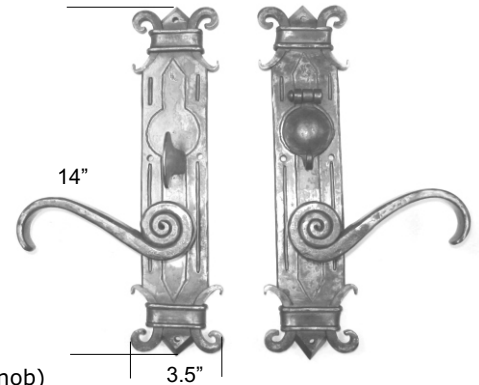

HE481 Chateau (shown w/HL103 Lever)

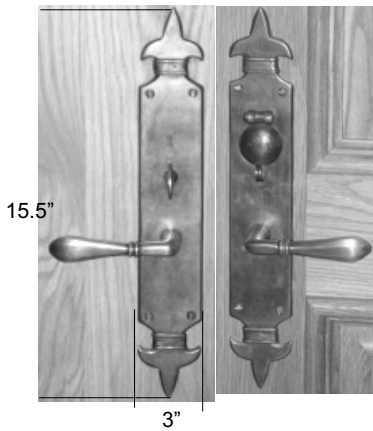

HE484 Fleur de Lis w/HL144 Lever

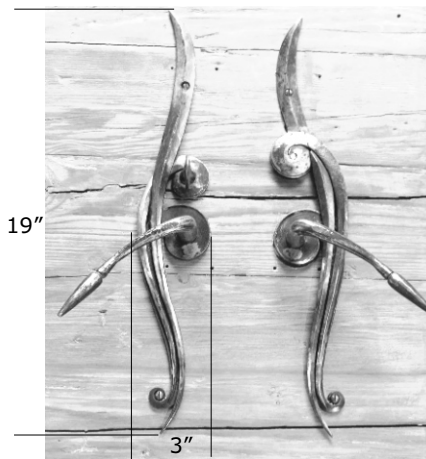

HL106 Louvre Lever Mortise Entry
(No lever or tubular deadbolt option)



AVAILABLE WITH MORTISE LOCK (EN-ML) OR TUBULAR DEADBOLT (EN-DB). AVAILABLE WITH ANY LEVER OR KNOB. (Tubular Deadbolt is made with 5.5" center-to-center standard)

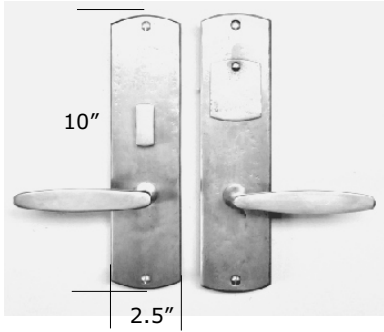

HE646 El Secreto with HL155 Lever

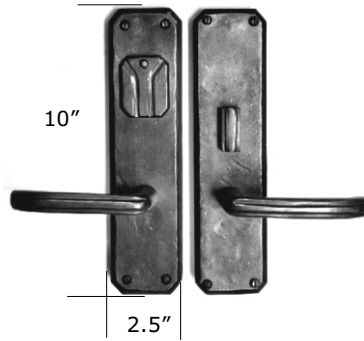

HE642 Monte Vista with HL156 Lever

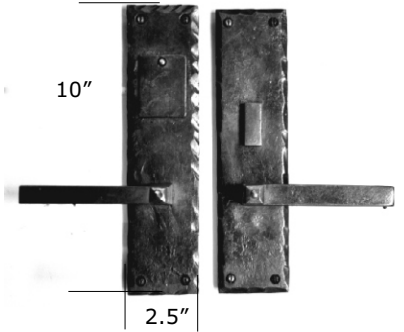

HE648 Cody with HL157 Lever

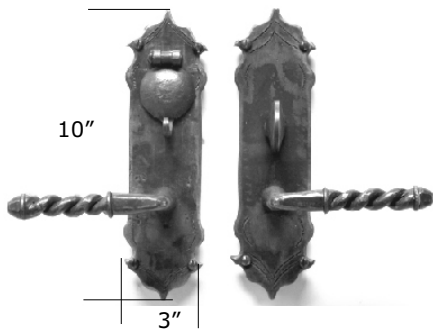

HE664 Avila with HL158 Lever

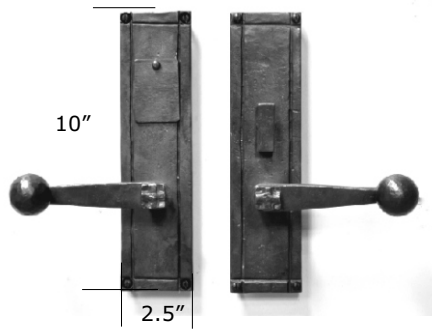

HE668 Sierra with HL159 Lever



HAND FORGED IRON ENTRY SETS

LEVER OR KNOB SECTIONAL DEADBOLT ENTRY SETS

WITH TUBULAR DEADBOLT (EN-DB)

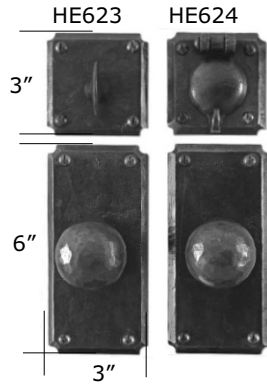

HE602 Notched Corner

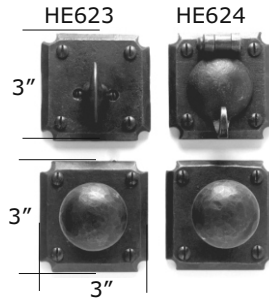

HE603 Notched Corner

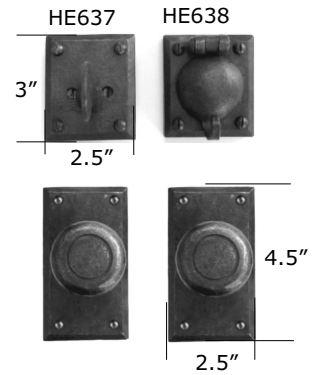

HE604 Beveled
(Or HE604NC Notched Corner)

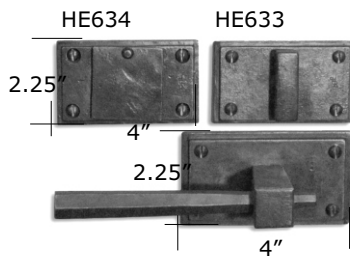

HE613 Horizontal Step

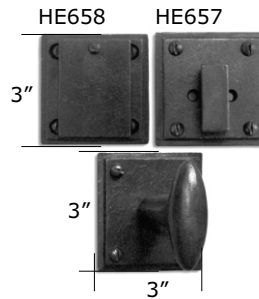

HE615 Step

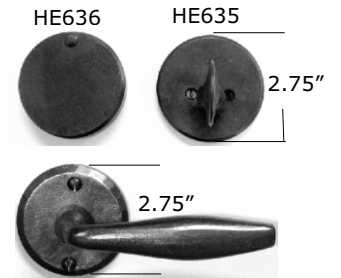

HE617 Round

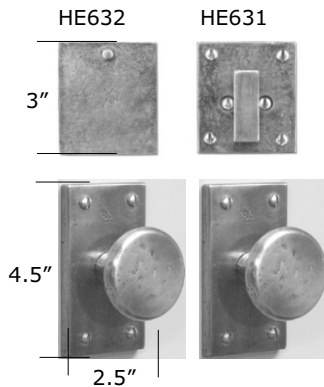

HE620 Straight Edge

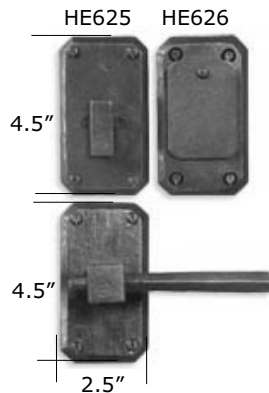

HE643 Skewed Corner

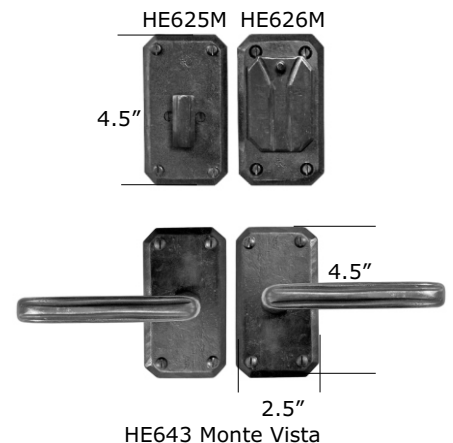

HE643 Monte Vista

All rights reserved. Rev 1014



HAND FORGED IRON ENTRY SETS

LEVER OR KNOB SECTIONAL DEADBOLT ENTRY SETS

WITH TUBULAR DEADBOLT (EN-DB)

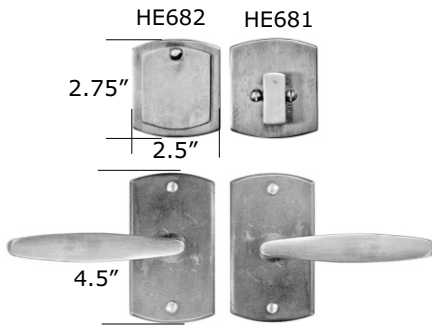

HE645 El Secreto

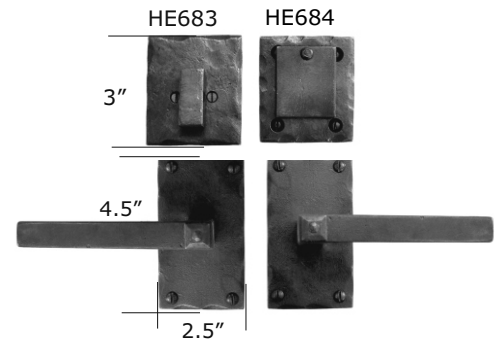

HE647 Cody

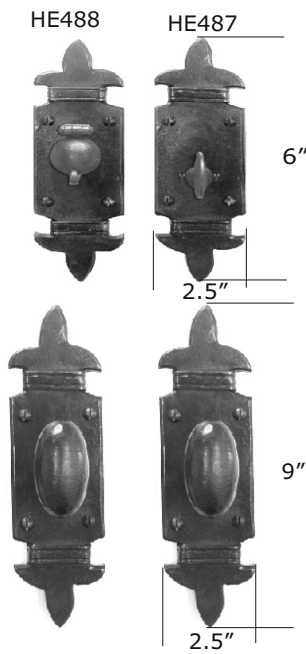

HE485 Fleur de Lis

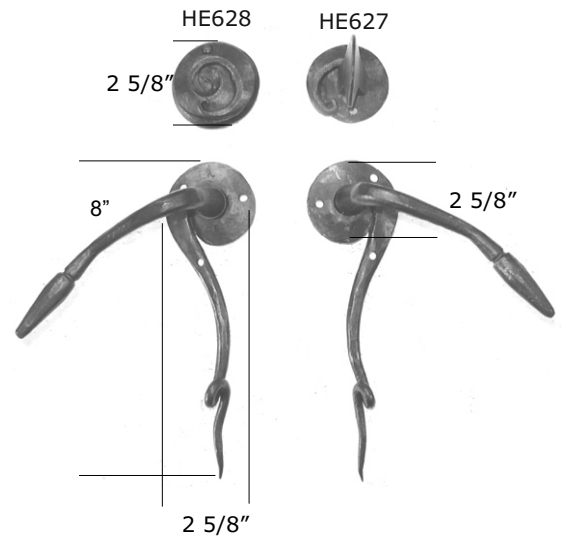

HL110 Louvre Deadbolt Entry (not for pre-bored doors)

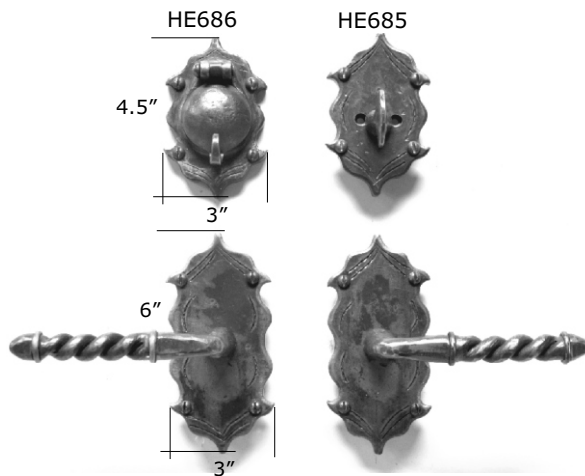

HE663 Avila

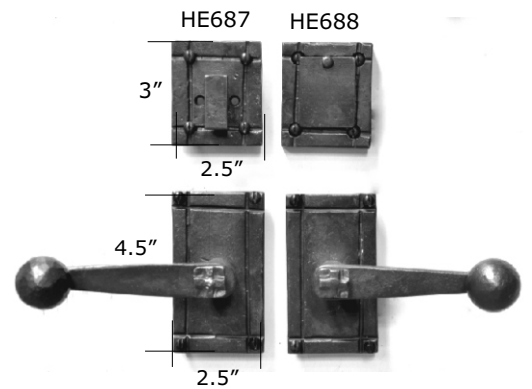

HE667 Sierra

All rights reserved. Rev 1014



WITH TUBULAR DEADBOLT (EN-DB)

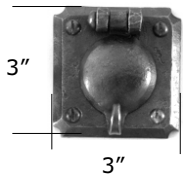

3"

3"

HE624

Notched Corner



HE623

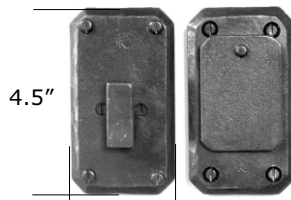

4.5"

2.5"

HE625



HE626

Skewed Corner

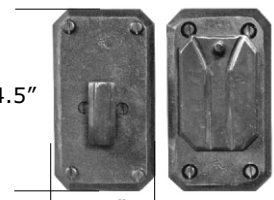

4.5"

2.5"

HE625M



HE626M

Monte Vista



2 5/8"

HE628

Art Nouveau



HE627

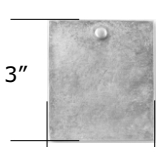

3"

2.5"

HE632

Straight Edge

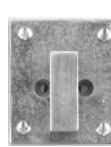

HE631

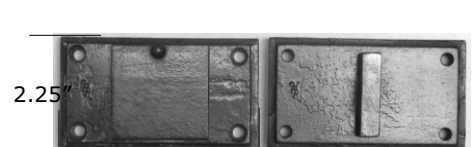

2.25"

4"

HE634

Horizontal Step



HE633



HE636

Round



HE635

2.75"

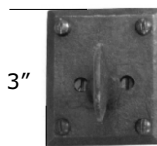

3"

2.5"

HE637

Beveled



HE638

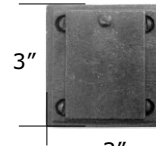

3"

HE658

Step

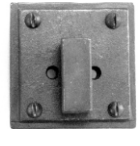

HE657



HE488

Fleur de Lis



HE487

6"

2.5"



2.75"

2.5"

HE682

El Secreto



HE681

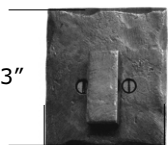

3"

2.5"

HE683

Cody



HE684



4.5"

3"

HE686

Avila



HE685

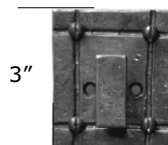

3"

2.5"

HE687

Sierra



HE688



OUR UNIQUE STRIKE-BAR ENTRY SETS ARE AVAILABLE WITH TUBULAR DEADBOLT (EN-DB) OR MORTISE DEADBOLT (EN-MD). The Extended bar goes on the active side of the door and acts as the latch. A partial mortise strike is included. Available with any lever unless specified.

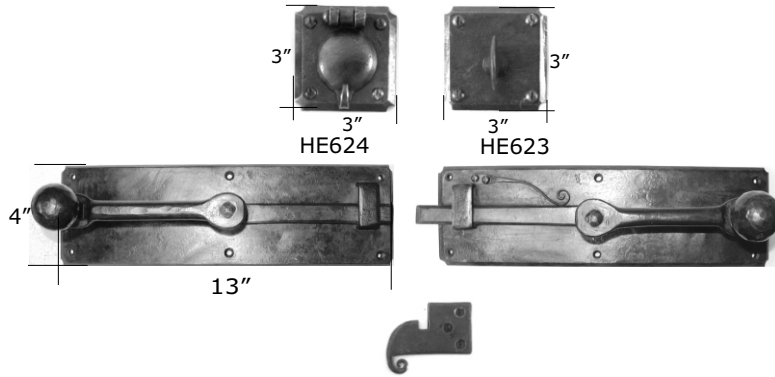

HS501 Horizontal Strike-bar Latch Entry (shown w/HL111 Lever)

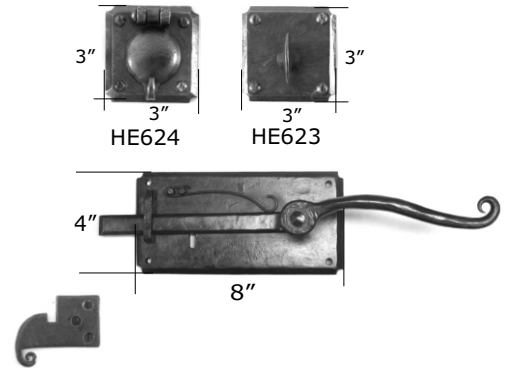

HS501S Entry (shown w/HL113 Lever)

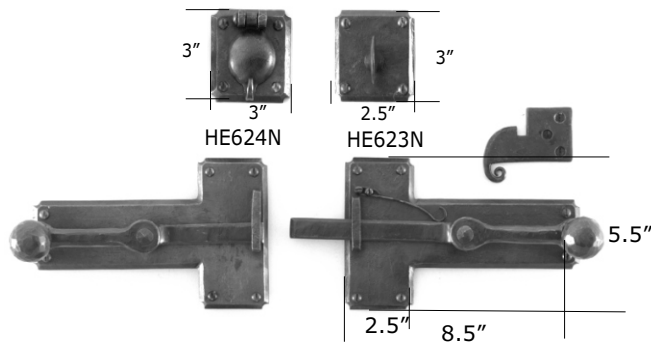

HS502 T-shaped Strike-bar Latch Entry (shown w/HL111)

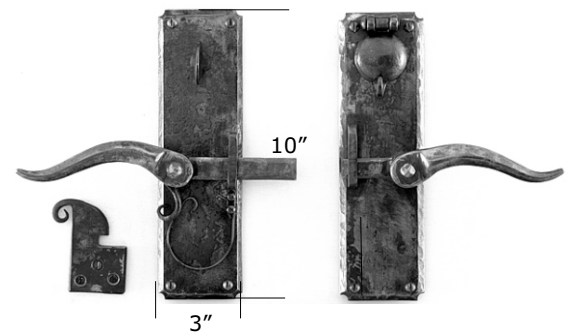

HS503 Vertical Strike-bar Latch Entry (shown w/HL101)

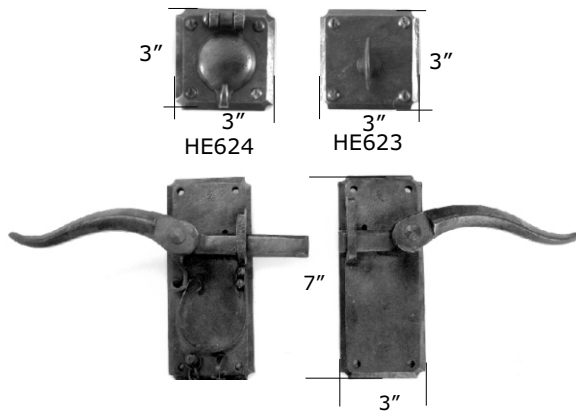

HS503S Entry (shown w/HL101)

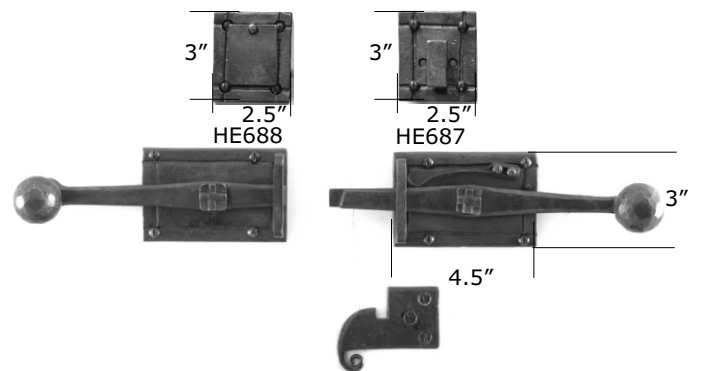

HS504 Tweezer Latch Entry (No Lever Option)



OUR UNIQUE STRIKE-BAR ENTRY SETS ARE AVAILABLE WITH TUBULAR DEADBOLT (EN-DB) OR MORTISE DEADBOLT (EN-MD). The Extended bar goes on the active side of the door and acts as the latch. A partial mortise strike is included. Available with any lever unless specified.



HS505 Stoker Latch Entry (No lever option)

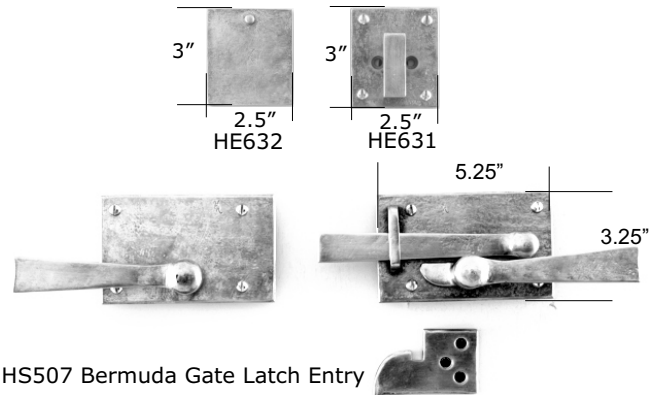

HS507 Bermuda Gate Latch Entry (No lever option)

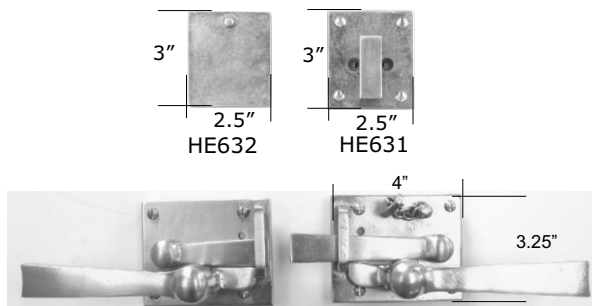

HS507S Entry (No lever option)

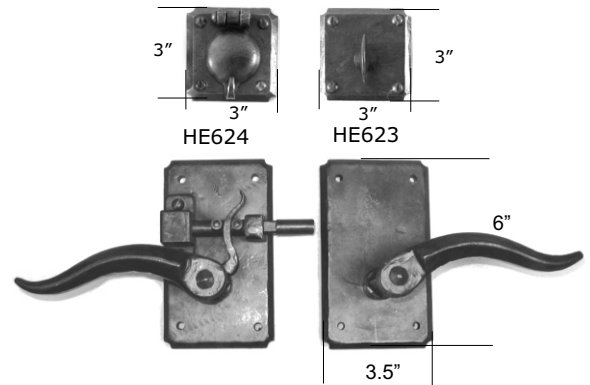

HS508 Santa Barbara Latch Entry (shown w/HL101)

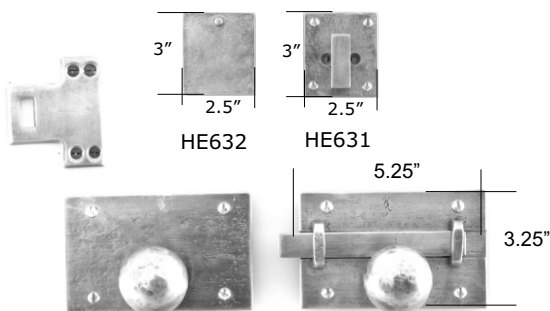

HS509 Scottsdale Latch Entry (No lever option)

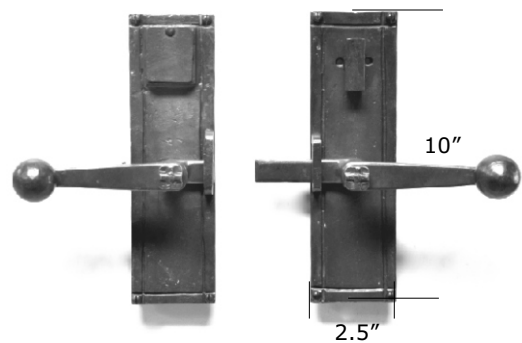

HS514 Sierra Strike-bar Latch Entry w/HL159



WE OFFER MULTIPOINT RETROFIT HARDWARE FOR MOST DOOR MAKES.
SEE SPEC SHEETS AND ORDER INFO FORM ON FOLLOWING PAGES FOR FUNCTIONS & REQUIRED SPECIFICATIONS.

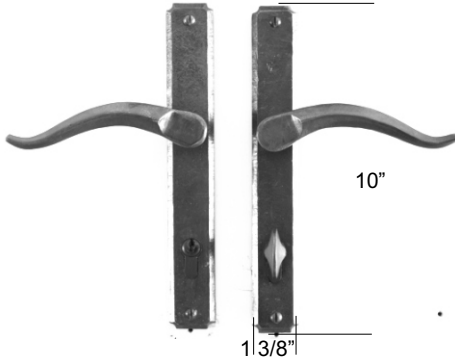

HE605 Straight Edge
HE605B Beveled (square corners)
HE605NC Notched Corner (shown)
No spring assist
(5" and smaller levers recommended)

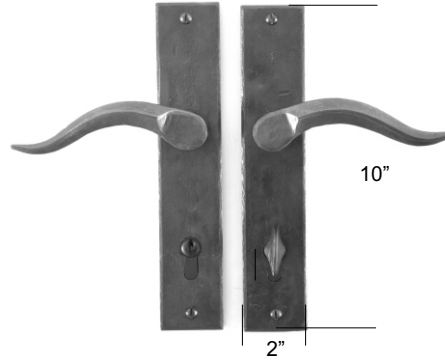

HE606 Straight Edge (shown)
HE606B Beveled (square corners)
HE606NC Notched Corner

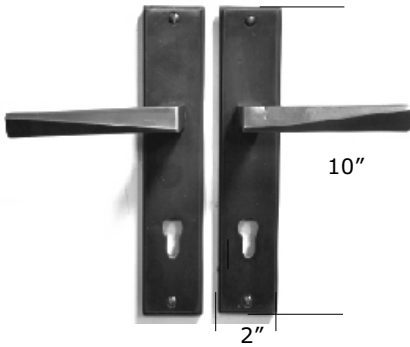

HE606S Step



HE489 Fleur de Lis
No spring assist
(5" and smaller levers recommended)

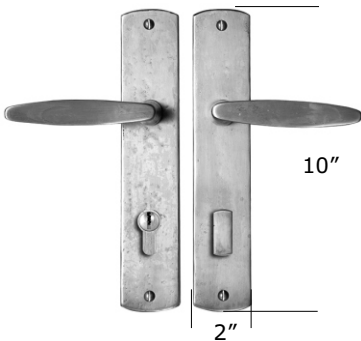

HE649 El Secreto

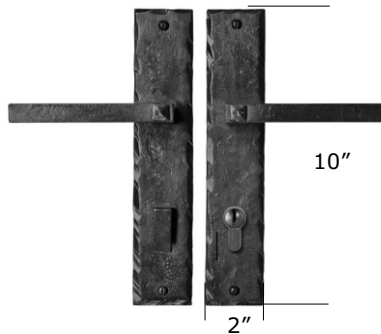

HE650 Cody

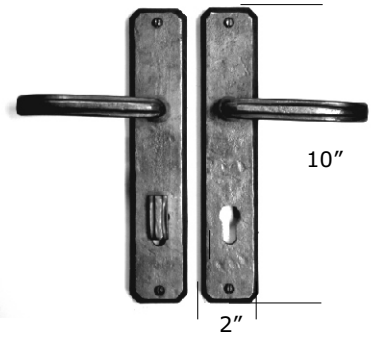

HE644 Monte Vista
(Skewed Corner)



WE OFFER MULTIPOINT RETROFIT HARDWARE FOR MOST DOOR MAKES.
SEE SPEC SHEETS AND ORDER INFO FORM ON FOLLOWING PAGES FOR FUNCTIONS & REQUIRED SPECIFICATIONS.

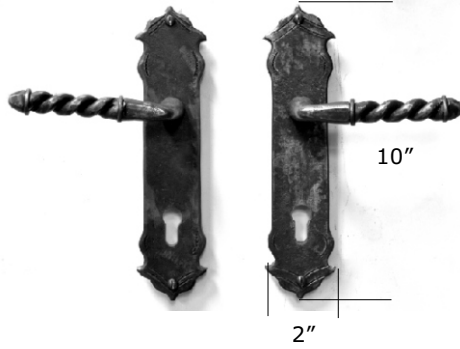

HE665 Avila

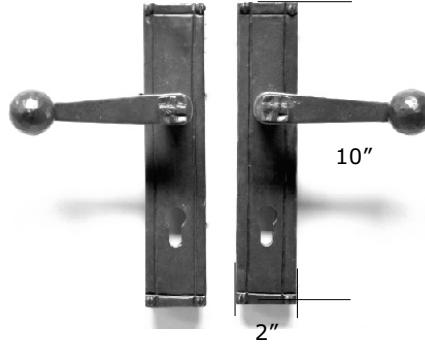

HE669 Sierra

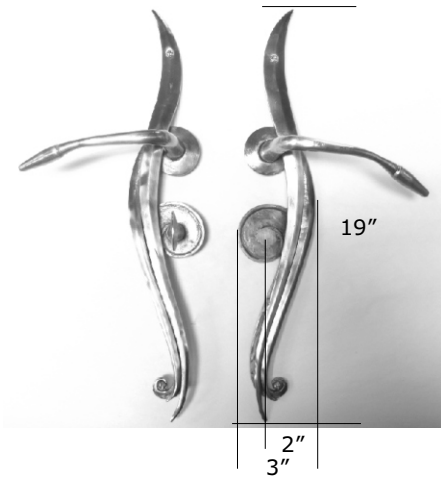

HL106MP Louvre (PATIO FUNCTION ONLY)



MULTIPOINT RETROFIT HARDWARE SPECIFICATION SHEET - PG.1
LEVER HIGH, AMERICAN CYLINDER SETS

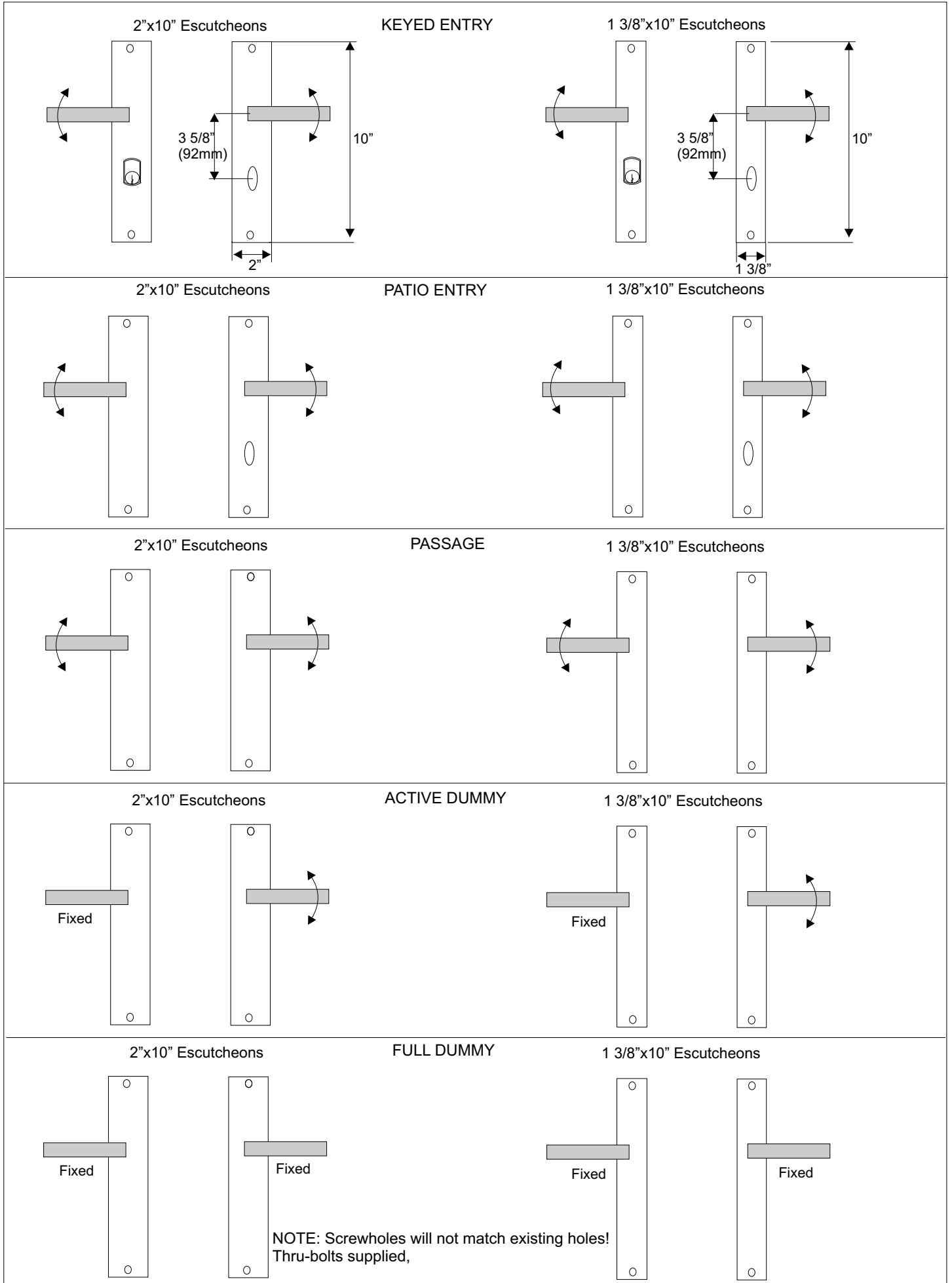

NOTE: Screwholes will not match existing holes!
Thru-bolts supplied,



MULTIPOINT RETROFIT HARDWARE SPECIFICATION SHEET - PG.2
LEVER LOW, AMERICAN CYLINDER SETS

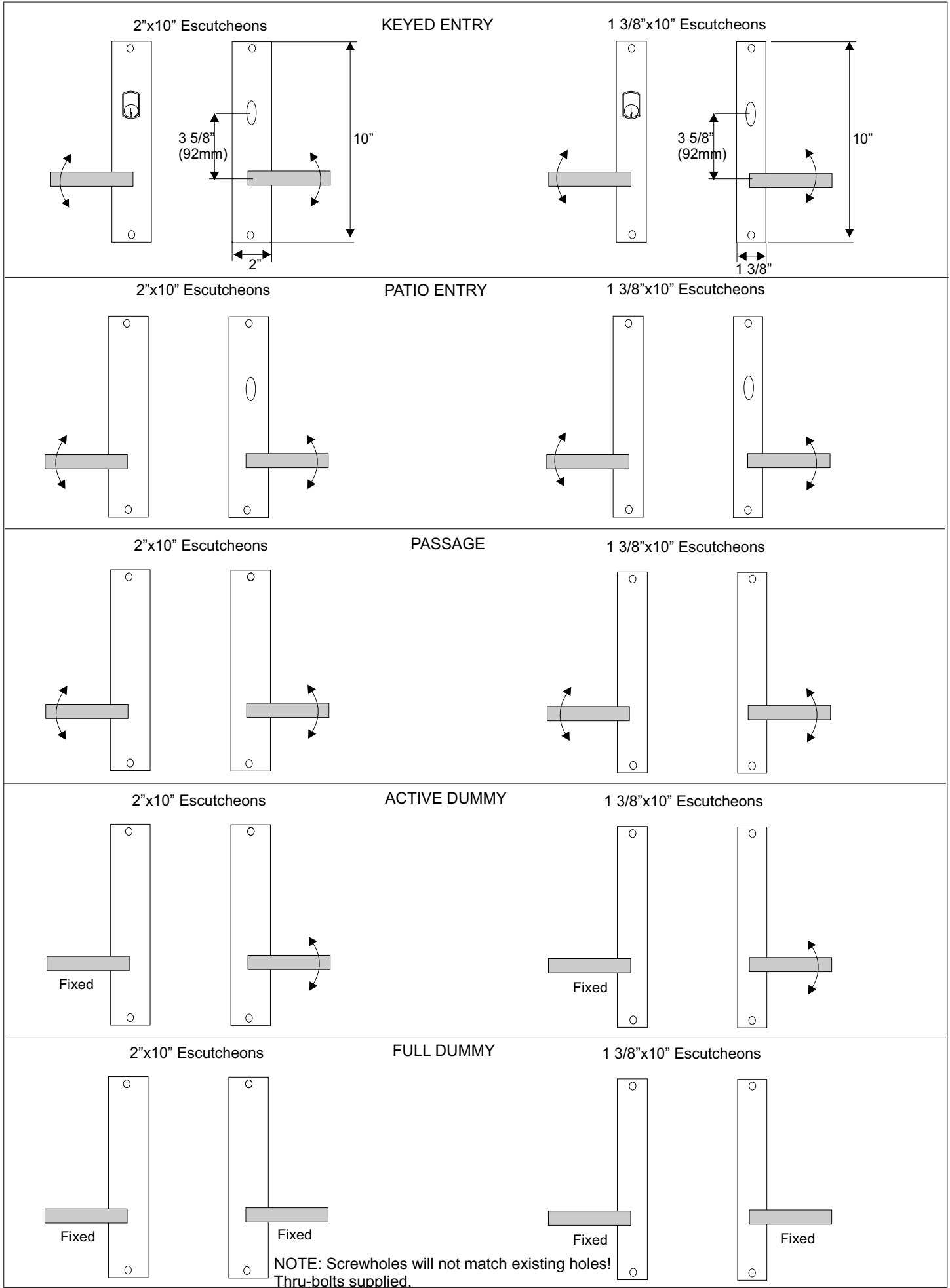

NOTE: Screwholes will not match existing holes!
Thru-bolts supplied.



MULTIPOINT RETROFIT HARDWARE SPECIFICATION SHEET - PG.3
LEVER HIGH, EUROPEAN PROFILE CYLINDER SETS

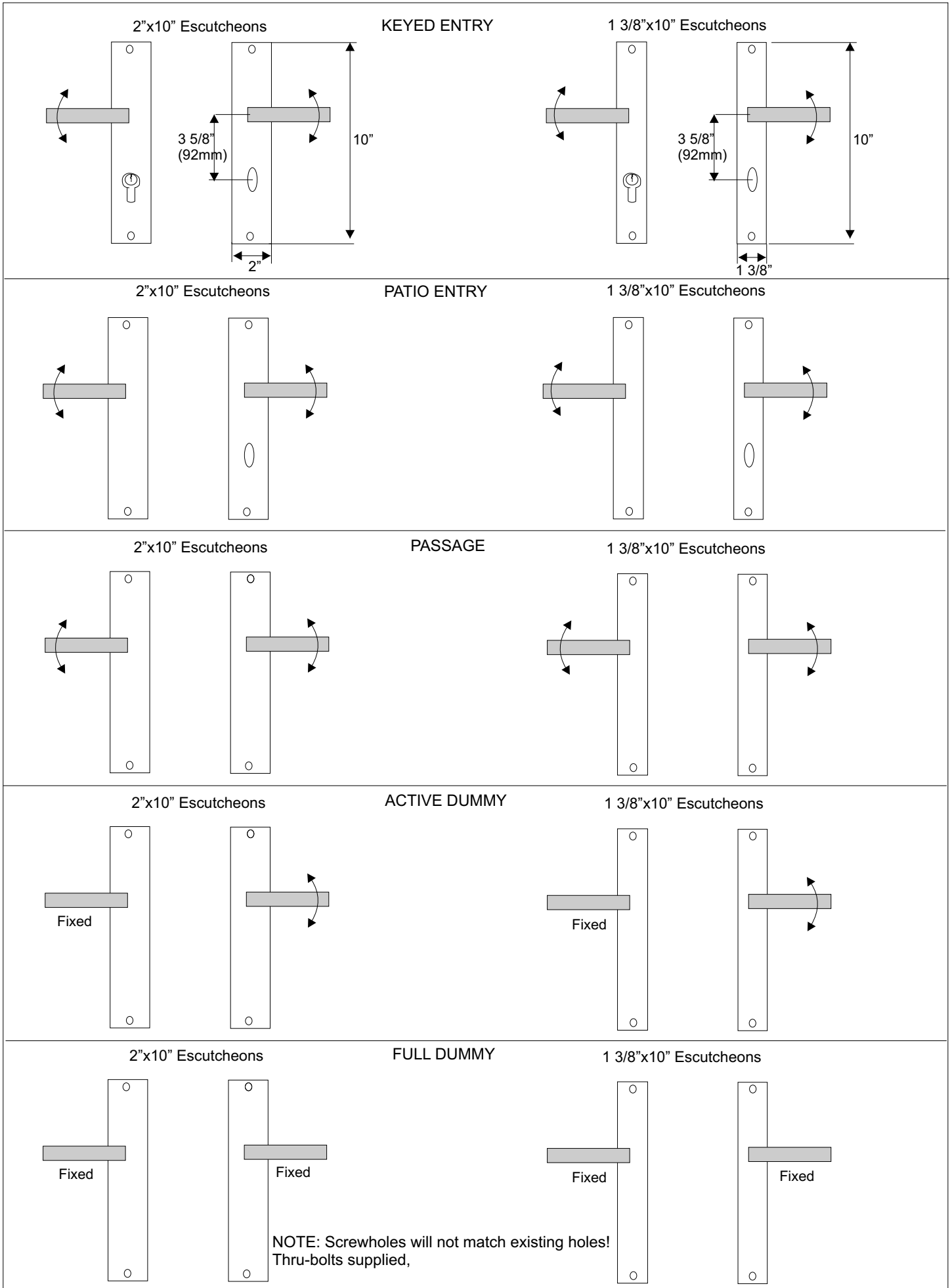



HARDWARE RENAISSANCE

MULTIPOINT RETROFIT HARDWARE FORM

PROVIDE THIS FORM WITH YOUR MULTIPOINT HARDWARE ORDER
(REFER TO MULTIPOINT SPEC SHEETS)

DATE

DEALER

PO#

* LOCK MAKE:

* DOOR THICKNESS (1.75" std.)

* CYLINDER:

EURO PROFILE

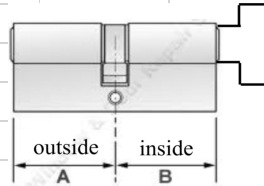

Centered in door (std.)

Offset

A:

B:

AMERICAN

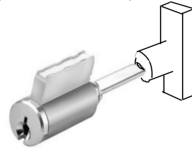

Tailpiece horizontal (std.)

Tailpiece vertical

* LEVER LOCATION:

High

Low

* CENTER TO CENTER (std. 92mm or 3 5/8"):

92mm

Other (specify)

* PASSIVE (NON-LOCKING) DOOR SETS:

FULL DUMMY (both levers fixed)

ACTIVE DUMMY (outside lever fixed, inside lever working)

PASSAGE (both levers working)

* SPINDLE (HUB) SIZE:

8mm square (std)

Other (specify)

THUMBTURNS: Contemporary styles with cuboid thumbturns. Classic styles with oval thumbturns.

HANDING guide:

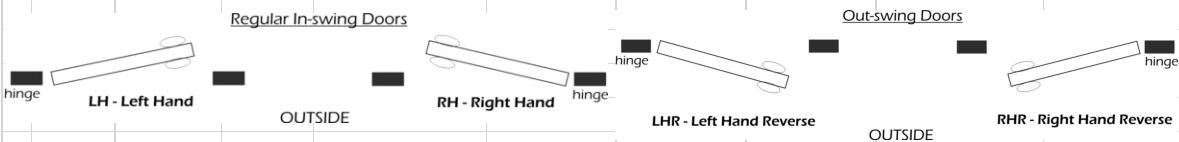

NOTE ABOUT OUR SCREW HOLE LOCATIONS: We do NOT match existing screw hole locations.

Our screw holes are made to miss existing holes. We provide thru-bolts for install.

NOTE: Door will also need holes made to accommodate the spring assist for levers



WE OFFER SLIDING DOOR HARDWARE FOR MOST DOOR MAKES.

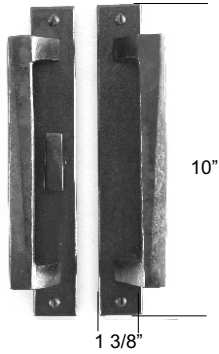

HE605 Escutcheon Patio set shown w/ HP656 Offset Milan 8" Grip



HE605 Escutcheon Patio set shown w/ HP657 Offset El Secreto 8" Grip

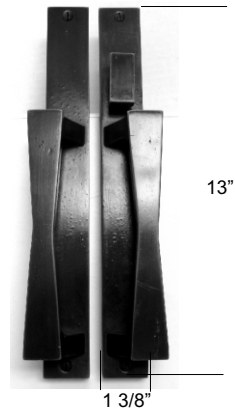

HE605L Escutcheon Patio set shown w/ HP444 Offset Manhattan 8" Grip

ALSO HE605B Beveled
HE605LNC Notched Corner

WE NEED THE FOLLOWING TO MAKE:

1. DOOR MAKE & SET-UP (GRIP LOW OR GRIP CENTERED)
2. CHOICE OF GRIP (choice of Milan, Manhattan, El Secreto Offset Grips or custom)
3. FUNCTION (ENTRY, PATIO, DUMMY). If ENTRY, specify American or Euro cylinder
4. HANDING (from the outside, active door sliding to the left or right)
5. TYPE OF SPINDLE (INSERT) for thumbturn

FILL OUT SLIDING DOOR INFORMATION FORM for all required specifications

NOTE: **WE DO NOT MATCH EXISTING SCREW HOLES.** OUR BACKPLATES ARE MADE TO MISS EXISTING HOLES. WE WILL MAKE SCREW HOLES AT THE TOP AND BOTTOM AND PROVIDE THROUGH-BOLTS FOR INSTALL.

SLIDING DOOR INFORMATION FORM

- PURCHASE ORDER # _____
- 1 Manufacturer _____
 - 2 Function _____
 - 3 Door Thickness _____
 - 4 Handing _____ (OX, XO, OR looking from the outside, the direction to which the door slides)
 - 5 Type of Spindle for turnpiece
(Circle one or send sketch if different)

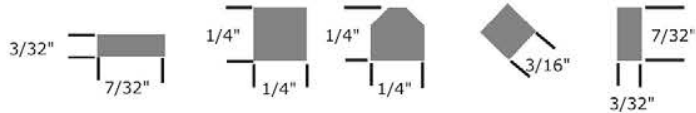

- 6 Hardware projection limitations (i.e. for screen door)? _____
- 7 Type of set-up and screw spacing (mark below OR supply drawing if different)

GRIP LOW

MAKE	DIM A	DIM B	DIM C
HOPPE	1-3/4" (1.772")	7-3/8" (7.362")	9-1/8" (9.134")
JELDWEN (A)	1-3/16" (1.818")	5-7/16" (5.427")	7-1/4" (7.245")
JELDWEN (B)	1-15/16" (1.945")	8-5/16" (8.300")	10-1/4" (10.245")
KOLBE	1-31/32" (1.969")	8-9/32" (8.277")	10-1/4" (10.246")
MARVIN	1-9/16" (1.584")	9-5/8" (9.643")	11-1/4" (11.227")
MARVIN INTEGRITY	1-15/16" (1.945")	9-31/32" (9.975")	11-15/16" (11.920")
PELLA	23/32" (.700")	7-5/16" (7.300")	8.000"
ANDERSEN	1-15/16" (1.950")	9-13/16" (9.800")	11-3/4" (11.75")
SIERRA PACIFIC	1-3/4" (1.771")	7-3/8" (7.361")	9-1/8" (9.132")
WINDSOR	1-31/32" (1.969")	9 15/16" (9.951")	11-15/16" (11.920")
OTHER			

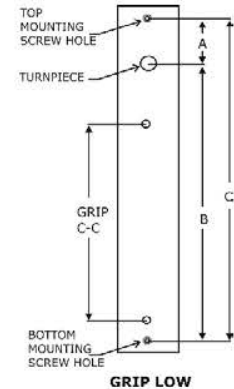

GRIP CENTERED

MAKE	DIM A	DIM B	DIM C
JELDWEN	2-23/32" (2.718")	1-1/4" (1.219")	3-15/16" (3.937")
EAGLE	1-1/4" (1.219")	2-23/32" (2.718")	3-15/16" (3.937")
MARVIN	4-15/16" (4.938")	4-15/16" (4.938")	9-7/8" (9.875")
MARVIN	1-15/16" (1.945")	1-15/16" (1.945")	3-31/32" (3.980")
OTHER			

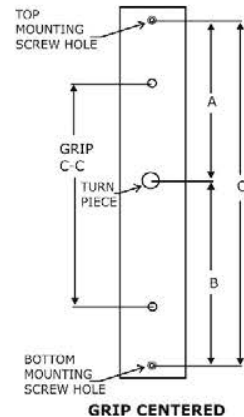

NOTE: WE DO NOT MATCH EXISTING SCREWHOLE. OUR BACKPLATES WILL MISS THEM.
WE PROVIDE THRU-BOLTS FOR INSTALL.

SLIDING DOOR RETROFIT TRIM IS NON-RETURNABLE

Signature _____

Date _____



HE605L Escutcheon Entry American Cylinder
set shown w/HL109-OS Offset Milan Lever

WE NEED THE FOLLOWING TO MAKE:

1. SPECIFY LEVER (choice of Milan, Manhattan, Scottsdale, or custom)
SPECIFY LEVERS FIXED OR WORKING.
2. SPECIFY FUNCTION (ENTRY OR PATIO)
3. SPECIFY TYPE OF CYLINDER (American or Euro Profile)
4. SPECIFY HANDING (from exterior side, active door sliding left or right)
5. Spindle size (for working levers)
6. SEND US LOCK TEMPLATE OR SKETCH SHOWING:
 - a) center-to-center between existing screw holes
 - b) center-to-center between lever and lock hub
 - c) LOCK height

NOTE: **WE DO NOT MATCH EXISTING SCREW HOLES.** OUR BACKPLATES ARE MADE TO MISS EXISTING HOLES. WE WILL MAKE SCREW HOLES AT THE TOP AND BOTTOM AND PROVIDE THROUGH-BOLTS FOR INSTALL.



LIFT & SLIDE SETS TYPICALLY CONSIST A FLUSH PULL OUTSIDE & LONG LEVER INSIDE.
STANDARD LEVER HUB IS 10MM SQUARE.

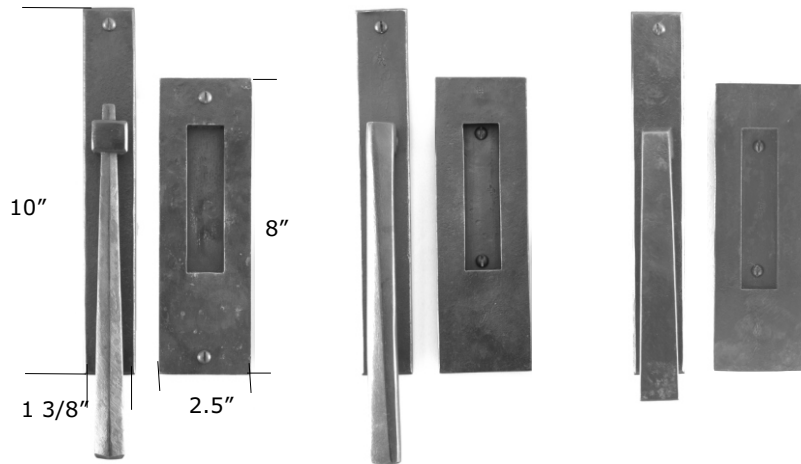

HE605 Escutcheon set shown w/ HL105L East-West 9" Lever & HP712 Flush Pull

HE605 Escutcheon set shown w/ HL109L Milan 9" Lever & HP712 Flush Pull

HE605 Escutcheon set shown w/ HL132L Manhattan 7" Lever & HP712 Flush Pull

PLEASE INQUIRE ABOUT OTHER LEVER & ESCUTCHEON OPTIONS



CONTENTS

This section contains all types of interior door hardware, such as passage, privacy, dummy sets, pocket door hardware, and door pulls.

IRON LEVER & KNOB OPTIONS	Page L1-L2
Escutcheons (Passage, Privacy, Dummy)	Page 2-1 / 2-2
Petite Series Levers, Knobs, Escutcheons	Page 2-3
Privacy Bolts	Page 2-4
Strike-bar Latch Passage, Privacy & Dummy sets	Page 2-5 / 2-6
Pocket Door Hardware	Page 2-7
Screen Door Hardware	Page 2-8
Door/ Appliance Pulls	Page 2-9 / 2-12
Push Plates	Page 2-13



HAND FORGED IRON LEVERS & KNOBS

THESE ARE OUR STANDARD LEVER & KNOB OPTIONS. PRICE INCLUDES CHOICE OF ANY OF THESE LEVERS OR KNOBS. **PRICE IS DETERMINED BY ESCUTCHEON.**



HL101 Verona



HL102 Soho



HL103 Casa California



HL105 East-West



HL107 Neha



HL108 Fleetwood



HL109 Milan



HL111 Ball



HL112 Spoon



HL113 Scrolled



HL116 East-West II



HL131 Accent

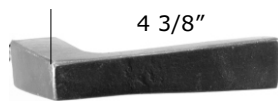

HL132 Manhattan

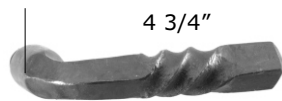

HL135 Toscana



HL136 Capri

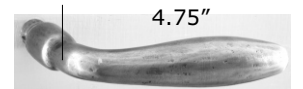

HL138 Del Mar



HL139 Chelsea



HL140 Bay



HL141 Scottsdale



HL142 Taos



HL143 Trio



HL144 Fleur de Lis

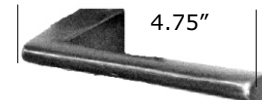

HL145 Salon

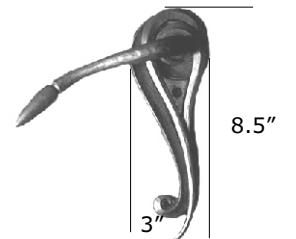

HL104 Art Nouveau

All rights reserved. Rev 1014



HAND FORGED IRON LEVERS & KNOBS

THESE ARE OUR STANDARD LEVER & KNOB OPTIONS. PRICE INCLUDES CHOICE OF ANY OF THESE LEVERS OR KNOBS. **PRICE IS DETERMINED BY ESCUTCHEON.**

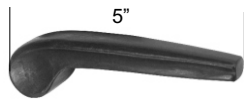

HL146 Mayfair



HL147 Taylor



HL148 Frisco

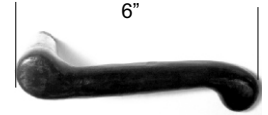

HL142 Carson



HL153 Loop

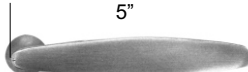

HL155 El Secreto



HL156 Monte Vista

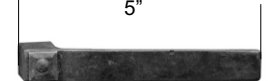

HL157 Cody



HL158 Avila



HL159 Sierra

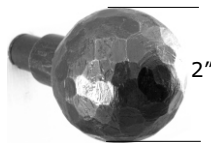

HK751 Forged Large

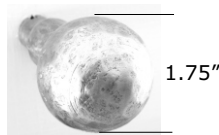

HK752 Forged Medium



HK753 Casa California

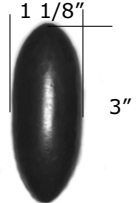

HK755 East-West

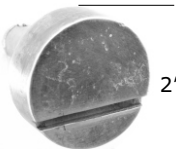

HK756 Sunrise

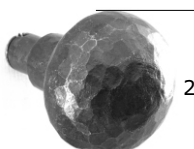

HK757L Mushroom Large

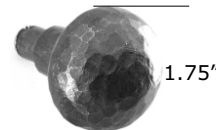

HK757 Mushroom



HK758 Martini

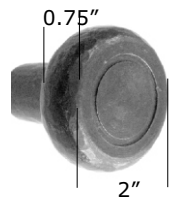

HK759 Hampton

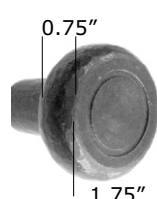

HK759M Hampton Medium

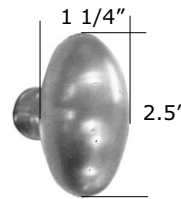

HK760 Bermuda



HP718 Ring Pull

All rights reserved. Rev 1014



HAND FORGED IRON INTERIOR DOOR HARDWARE

PASSAGE, PRIVACY, & DUMMY ESCUTCHEONS

PRICE IS DETERMINED BY ESCUTCHEON. Price includes any lever, knob, or ring pull (except where noted).



HE485 Fleur de Lis

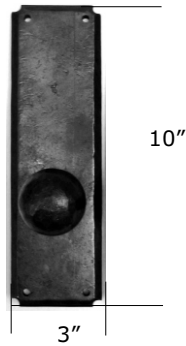

HE601 Notched Corner

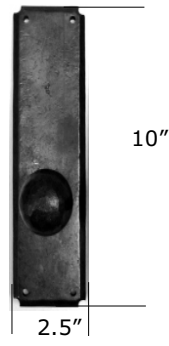

HE601N Notched Corner

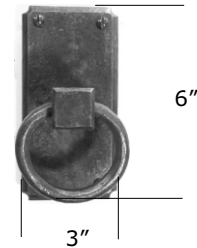

HE602 Notched Corner

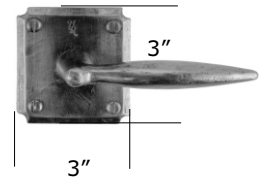

HE603 Notched Corner

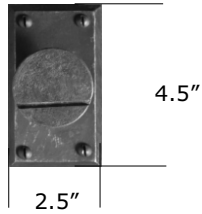

HE604 Beveled (square corners)

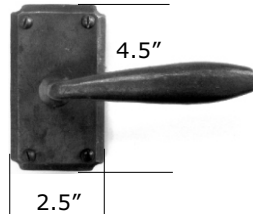

HE604NC Notched Corner

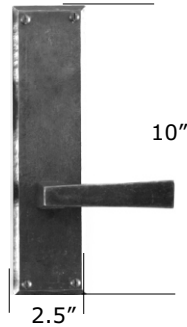

HE607 Beveled

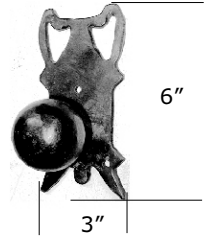

HE611 Gothic*

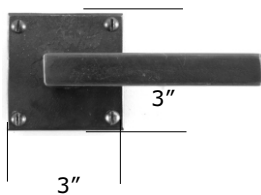

HE612 Straight Edge

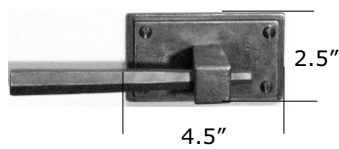

HE613 Horizontal Step

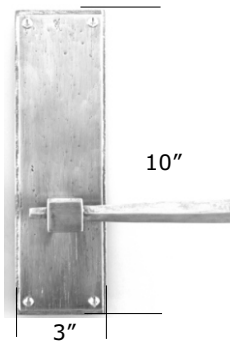

HE614 Step

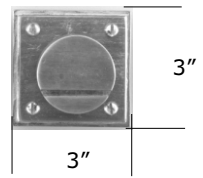

HE615 Step

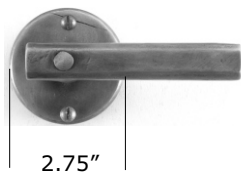

HE617 Round

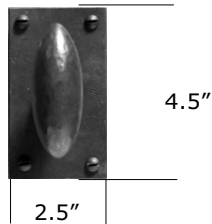

HE620 Straight Edge

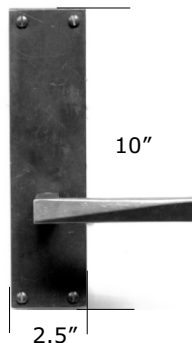

HE621 Straight Edge

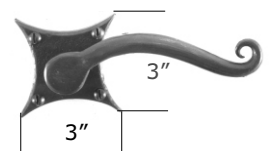

HE641 Scallop*

*WILL NOT WORK WITH PRE-BORED DOORS!

All rights reserved. Rev 1014



HAND FORGED IRON INTERIOR DOOR HARDWARE

PASSAGE, PRIVACY, & DUMMY ESCUTCHEONS

PRICE IS DETERMINED BY ESCUTCHEON. Price includes any lever, knob, or ring pull (except where noted).

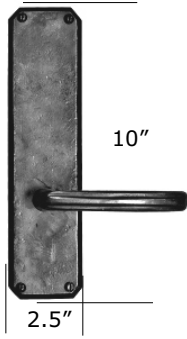

HE642 Monte Vista (Skewed Corner)

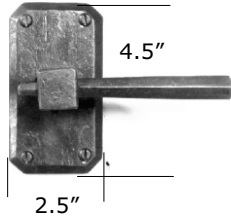

HE643 Monte Vista (Skewed Corner)

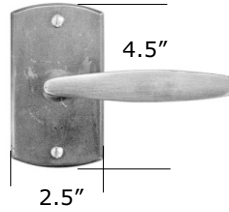

HE645 El Secreto

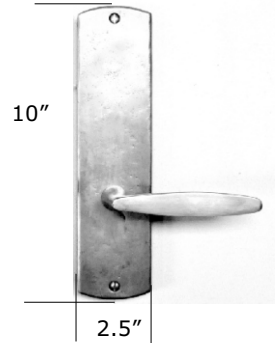

HE646 El Secreto

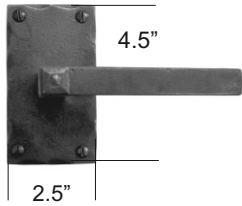

HE647 Cody

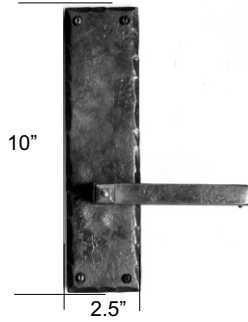

HE648 Cody

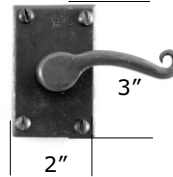

HE651 Straight Edge*

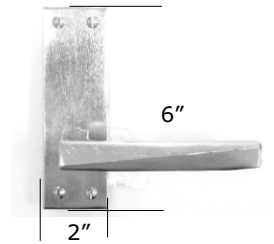

HE652 Straight Edge*

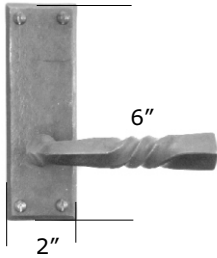

HE652B Beveled*

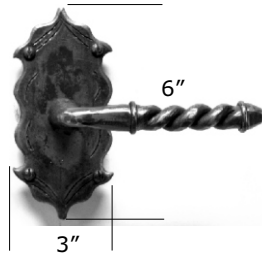

HE663 Avila

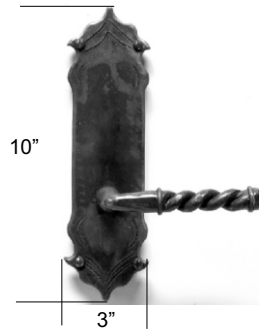

HE664 Avila

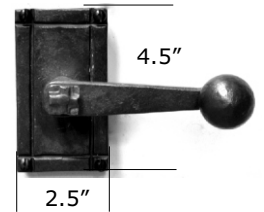

HE667 Sierra

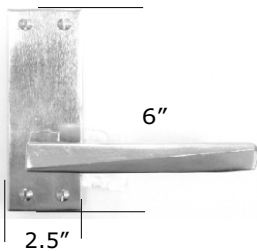

HE652W Straight Edge

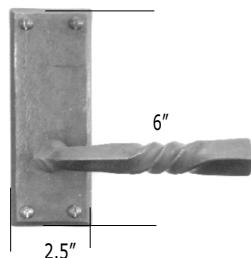

HE652WB Beveled

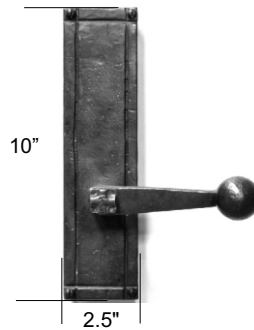

HE668 Sierra

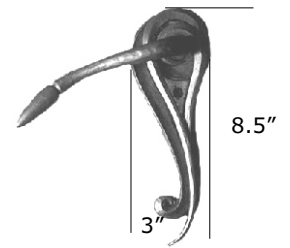

HL104 Art Nouveau*

*WILL NOT WORK WITH PRE-BORED DOORS!

All rights reserved. Rev 1014



HAND FORGED IRON INTERIOR DOOR HARDWARE

PETITE SERIES LEVERS & ESCUTCHEONS

THE FOLLOWING LEVER/ KNOB & ESCUTCHEON SETS ARE AVAILABLE AT PETITE SERIES PRICING.

Tubular Passage, Privacy, & Dummy sets only. Available in all patinas.



HL121 Petite Verona



HL122 Petite Neha



HL123 Petite Wave



HL124 Petite Soho



HL125 Petite Casa California

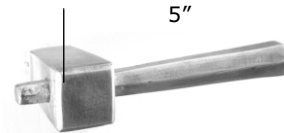

HL126 Petite East-West

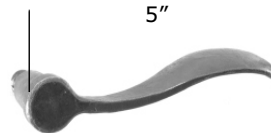

HL127 Petite Spoon



HL128 Petite Scrolled



HL140 Bay

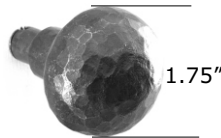

HK757 Mushroom

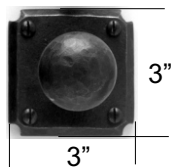

HE603 Notched Corner

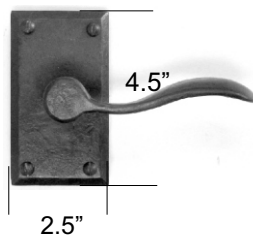

HE604 Beveled
or HE604NC Notched Corner

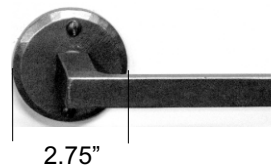

HE617 Round*

*WILL NOT WORK WITH PRE-BORED DOORS!

All rights reserved. Rev 1014



PRIVACY MORTISE BOLTS (PMB) CAN BE ORDERED ON THEIR OWN OR ADDED TO ANY PASSAGE SET

EMERGENCY EGRESS COVER (OUTSIDE):



PMB-CO1

AVAILABLE THUMBTURNS (INSIDE):

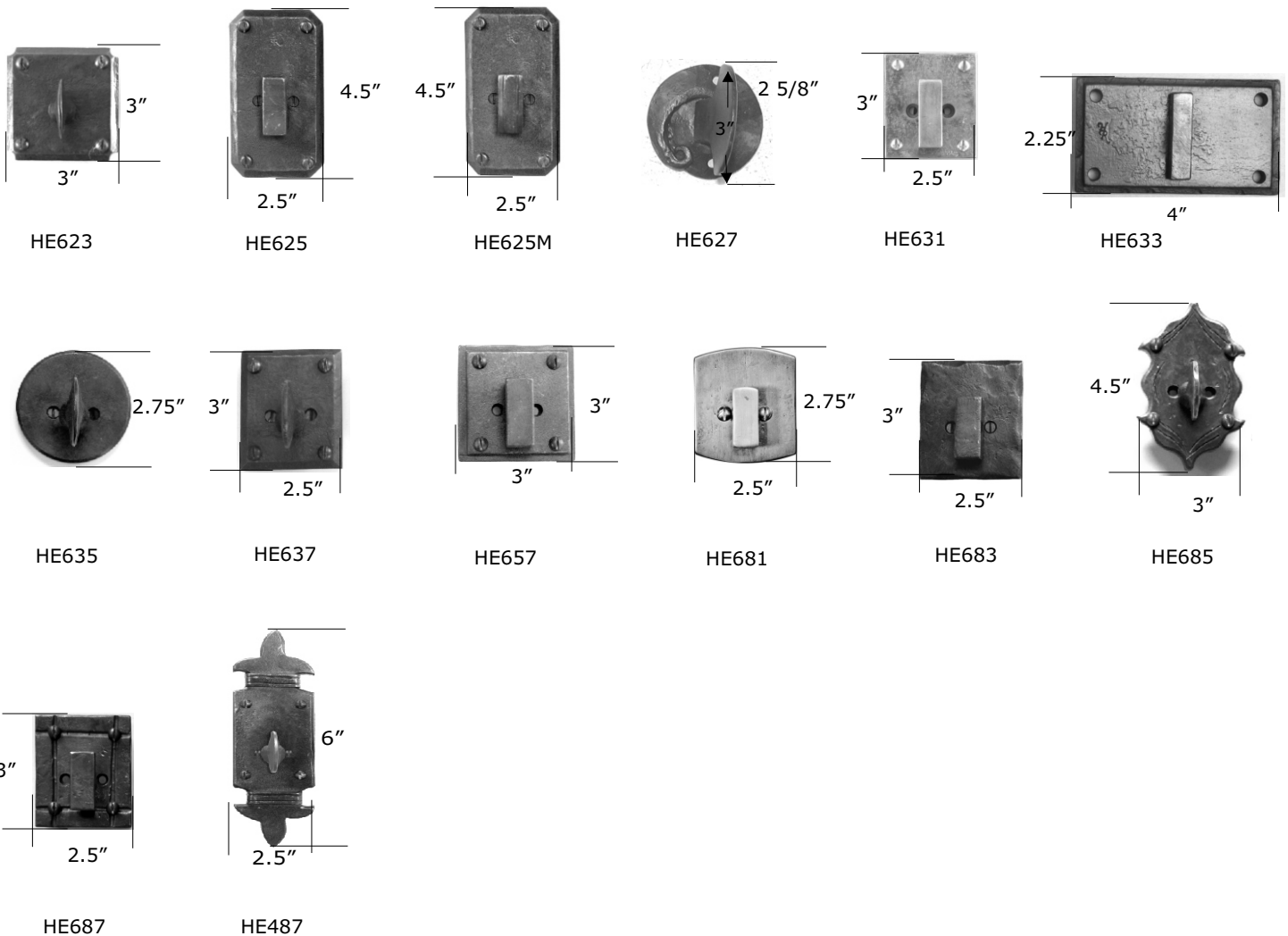



STRIKE-BAR LATCH PASSAGE, PRIVACY, DUMMY SETS

OUR UNIQUE STRIKE-BAR SETS ARE AVAILABLE IN PASSAGE, PRIVACY & DUMMY FUNCTIONS. The Extended bar goes on the active side of the door and acts as the latch. A partial mortise strike is included. Available with any lever unless specified.

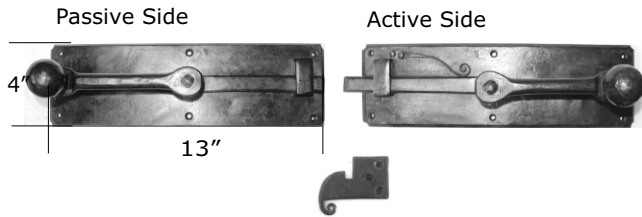

HS501 Horizontal



HS501S Horizontal

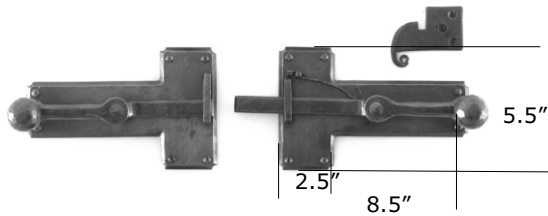

HS502 T-Shaped

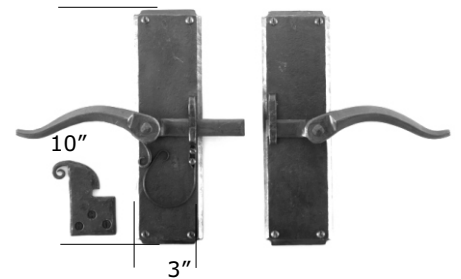

HS503 Vertical

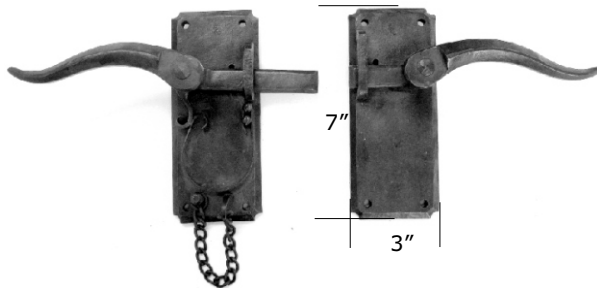

HS503S Vertical

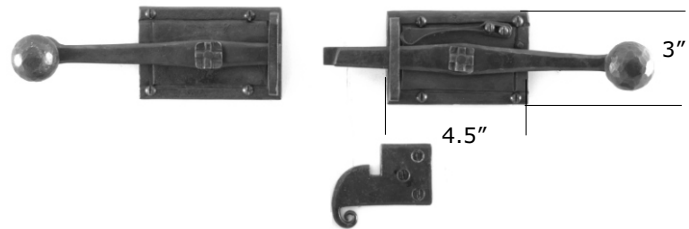

HS504 Tweezer
(No lever option)

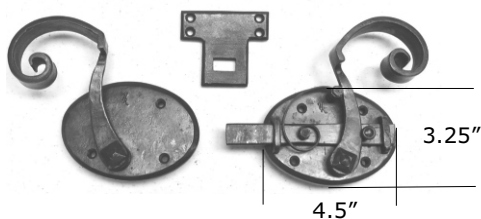

HS505 Stoker
(No lever option)

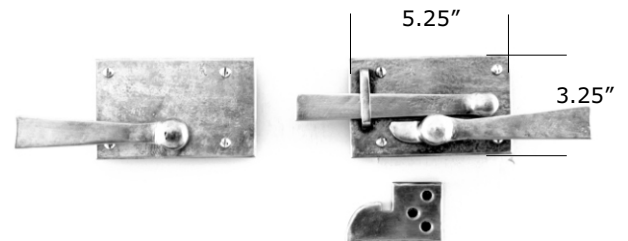

HS507 Bermuda
(No lever option)

NOTE: ALL STRIKE-BAR LATCH SETS INCLUDE SPINDLE. NO OTHER COMPONENT REQUIRED.
All strike-bar latches require a minimum stile width of 4.5".
They also require 0.25" clear space of jamb adjoining door for acceptance of mortise strike.

All rights reserved. Rev 1014



HAND FORGED IRON INTERIOR DOOR HARDWARE

STRIKE-BAR LATCH PASSAGE, PRIVACY, DUMMY SETS

OUR UNIQUE STRIKE-BAR SETS ARE AVAILABLE IN PASSAGE, PRIVACY & DUMMY FUNCTIONS.
The Extended bar goes on the active side of the door and acts as the latch. A partial mortise strike is included.
Available with any lever unless specified.

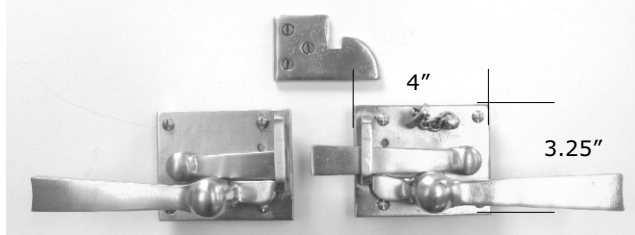

HS507S Petite Bermuda
(No lever option)

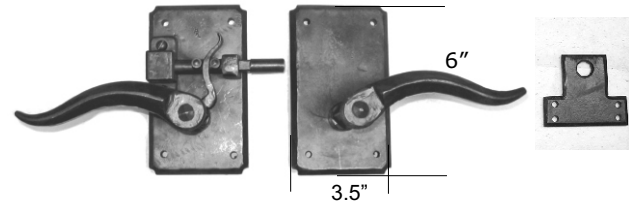

HS508 Santa Barbara

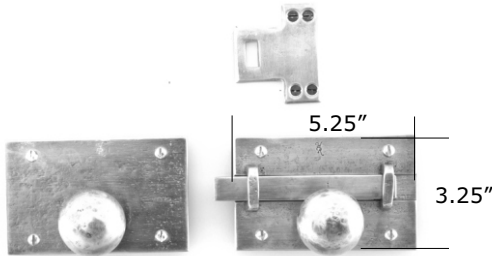

HS509 Scottsdale
(No lever option)

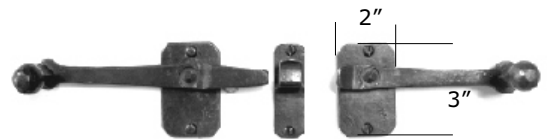

HS510 Petite Latch
(No lever option)

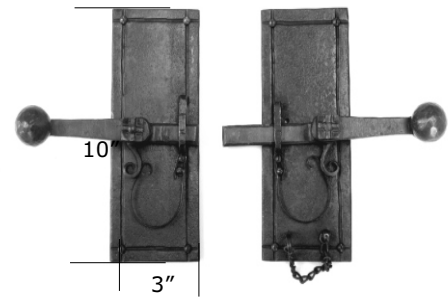

HS514 Sierra
(No lever option)

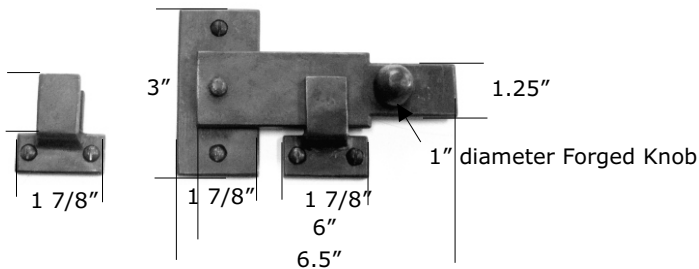

HS522 Barn Door Latch (ONE SIDE ONLY)

NOTE: ALL STRIKE-BAR LATCH SETS INCLUDE SPINDLE. NO OTHER COMPONENT REQUIRED.

All strike-bar latches require a minimum stile width of 4.5".

They also require 0.25" clear space of jamb adjoining door for acceptance of mortise strike.

All rights reserved. Rev 1014



PASSAGE FLUSH PULLS

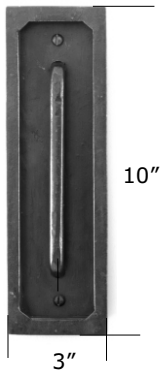

HP711

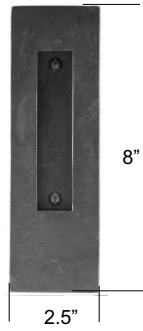

HP712



HP713

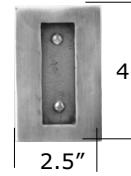

HP714

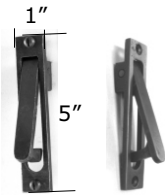

HP710 Edge Pull

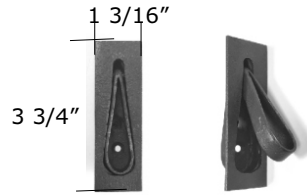

HP804 Tear Drop Edge Pull

HP-711 & HP712 POCKET MORTISE SETS available in Privacy or Keyed
(Minimum 1.75" door thickness)

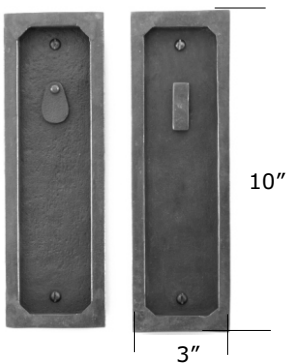

HP711 Pocket Privacy Set

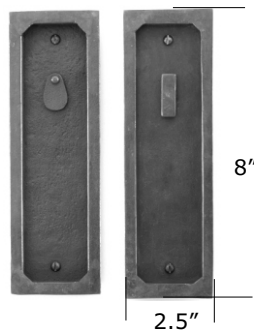

HP712 Pocket Privacy Set



Our Screen door hardware is available with 2" wide Escutcheons in Passage, Privacy, & Dummy sets.

Available in 1.5", 1.75" & 2" backsets.

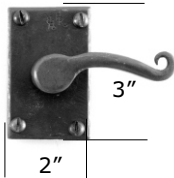

HE651 Straight Edge* (with tubular latch)

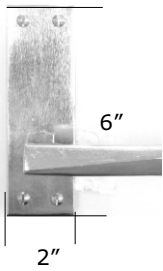

HE652 Straight Edge*

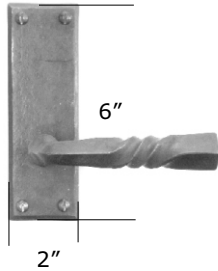

HE652B Beveled*
OR HE652NC Notched Corner*

*WILL NOT WORK WITH PRE-BORED DOORS!

All rights reserved. Rev 1014



AVAILABLE FOR FRONT MOUNT OR BACK-TO-BACK MOUNTING (specify door thickness)

Available with or without escutcheon

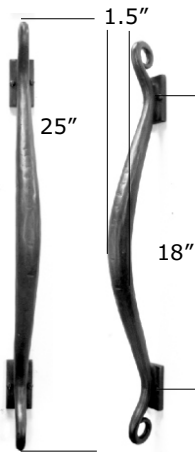

HP113L Scrolled Pull (4" projection)



HP441 Normandy (3.75" projection)



HP442 Seville (3.75" projection)

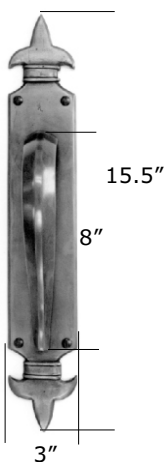

HP484 Fleur de Lis w/escutcheon (3.5" projection)

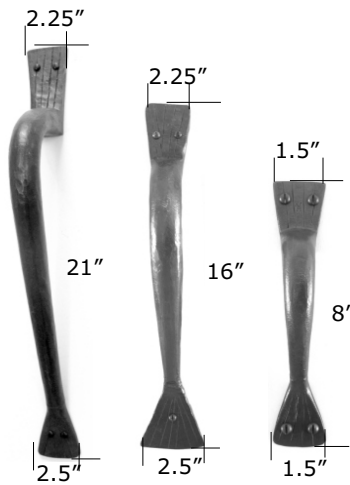

HP701L HP701 HP701S
Fishtail Pulls (4" projection)

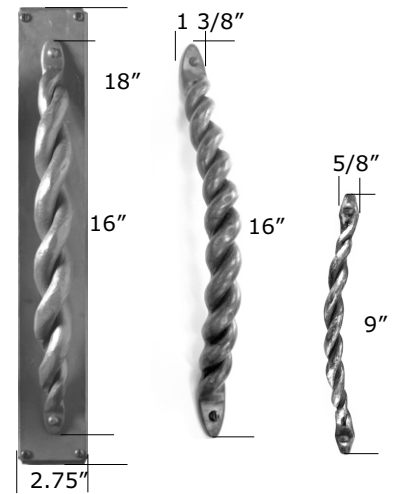

HP702-ESC HP702 HP703
Rope Pulls (4" projection)

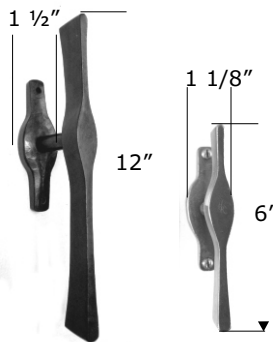

HP705 HP705S
East-West Pulls (3.5" projection)

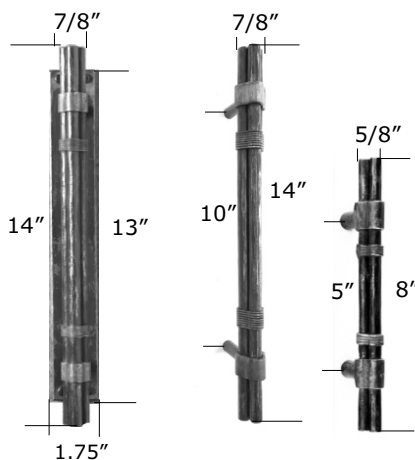

HP706-ESC HP706 HP706S
Trio Pulls (3.5" projection)

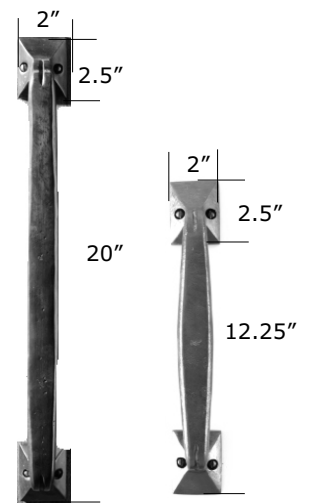

HP707L HP707
El Secreto Pulls (2.5" projection)

All rights reserved. Rev 0118



AVAILABLE FOR FRONT MOUNT OR BACK-TO-BACK MOUNTING (specify door thickness)

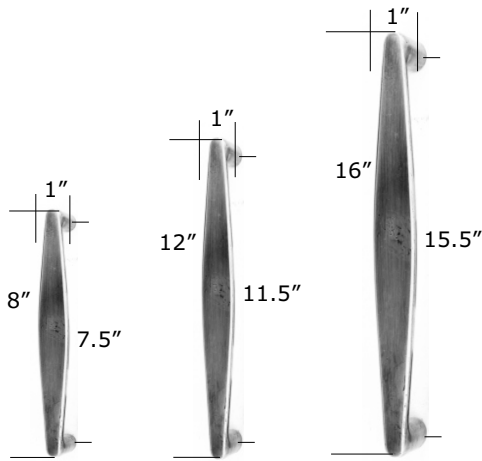

HP707S-AP-8 HP707S-AP-12 HP707S-AP-16
El Secreto Appliance Pulls (1.75" projection)

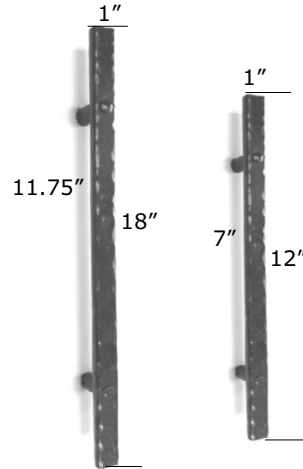

HP708AP-18 HP708AP-12
Rectangular Pulls (2" projection)

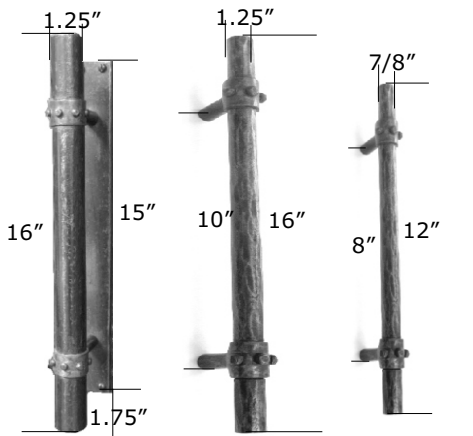

HP709-ESC HP709 HP709-12
Galisteo Pulls (3.5" projection)

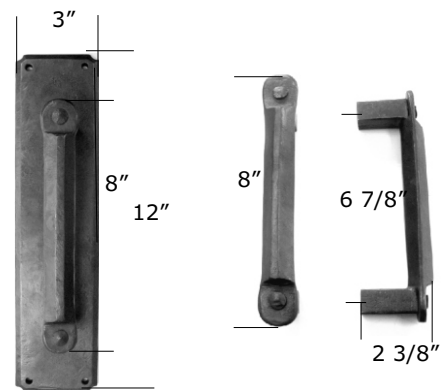

HP724-ESC Verona HP724-8 Verona
(2.75" projection)

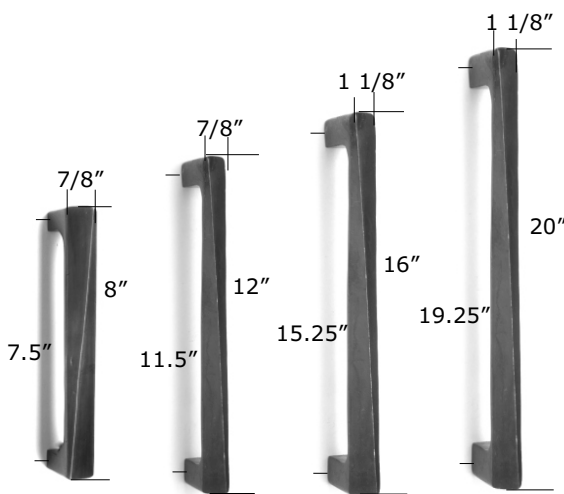

HP725-8 HP725-12 HP725-16 HP725-20
Milan Pulls (2" projection)

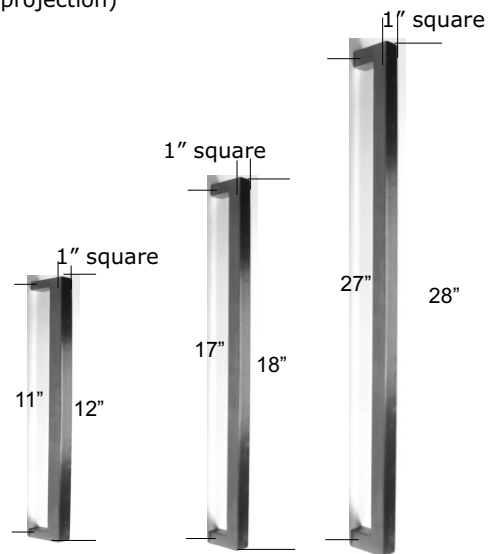

HP726AP-12 HP726AP-18 HP726AP-28
Stockholm Pulls (2.5" projection)



AVAILABLE FOR FRONT MOUNT OR BACK-TO-BACK MOUNTING (specify door thickness)

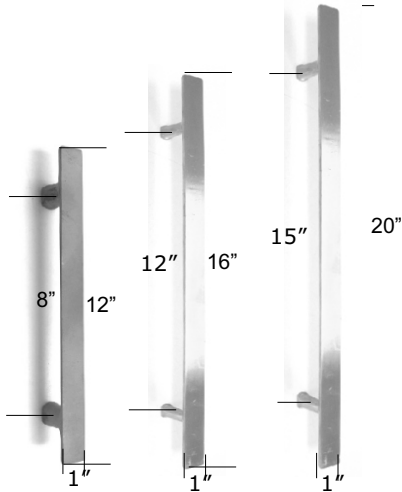

HP754L-AP-12 HP754L-AP-16 HP754L-AP-20
Scottsdale Pulls (2" projection)

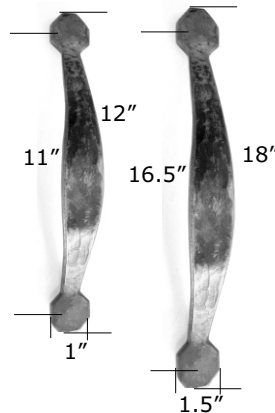

HP767AP-12 HP767AP-16
Hampton Pulls (1.75" projection)

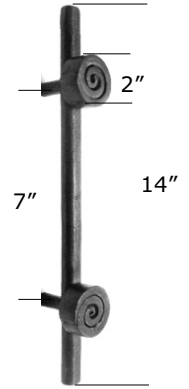

HP771 Casa California
(2.5" projection)

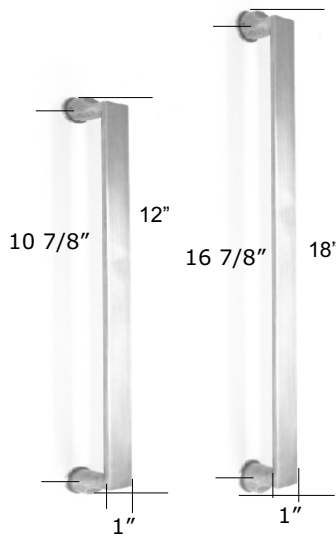

HP772AP-12 HP772AP-18
Prescott Pulls (2" projection)

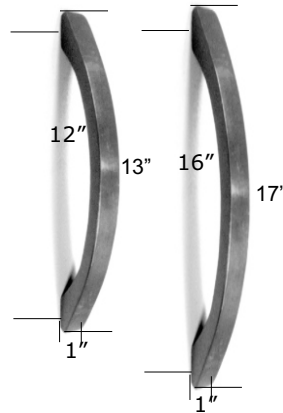

HP773AP-12 HP773AP-16
Arc Pulls (2" projection)



HP783 Balboa
(4.5" projection)



HP785 Avila Pull
(3.25" projection)



AVAILABLE FOR FRONT MOUNT OR BACK-TO-BACK MOUNTING (specify door thickness)

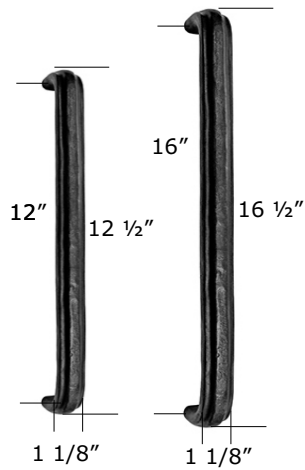

HP791AP-12 HP791AP-16
Monte Vista Pulls (2.25" projection)

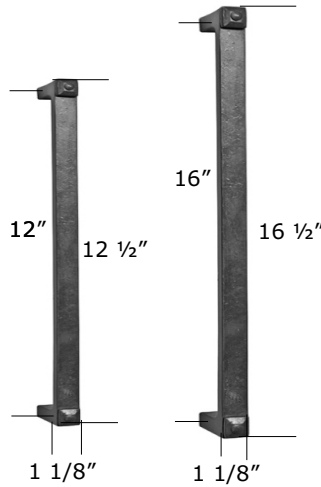

HP793AP-12 HP793AP-16
Cody Pulls (2.25" projection)

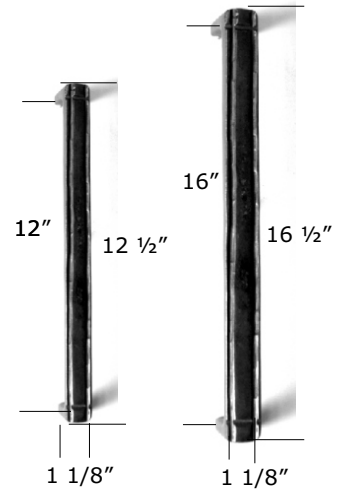

HP797AP-12 HP797AP-16
Sierra Pulls (2.25" projection)

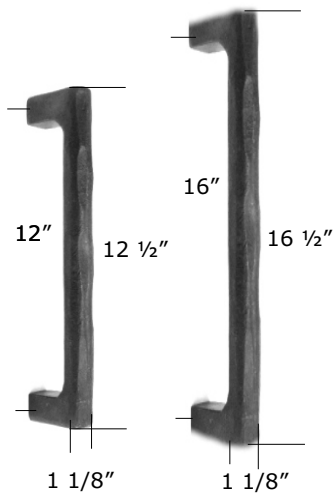

HP798AP-12 HP798AP-16
Dixon Pulls (2.25" projection)



AVAILABLE FOR FRONT MOUNT OR BACK-TO-BACK MOUNTING (specify door thickness)

PUSH PLATES

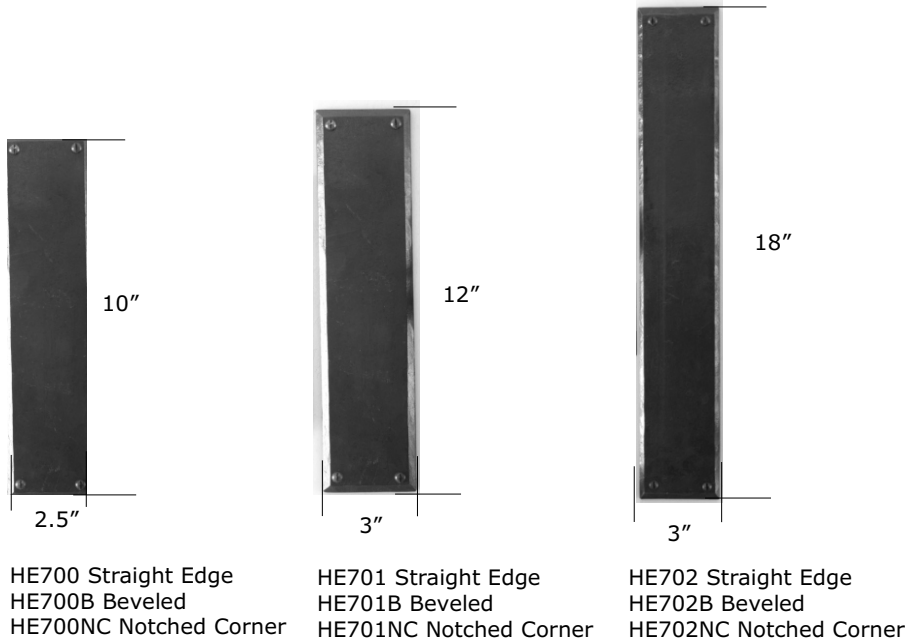



CONTENTS

This section contains door accessories, other accessories, and window hardware

Dummy Straps & Braces	Page 3-1
Strap Hinges	Page 3-2
Pintle Door & Cabinet Hinges	Page 3-3 / 3-4
Surface Bolts & Cane Bolts	Page 3-5
Door Knockers & Kick Plates	Page 3-6
Speakeasy Grilles, Latches, & Strap Hinges	Page 3-7
Clavos	Page 3-8
Door Stops & Hook-and-Eye	Page 3-9
Door Bell Buttons & Switch Plate Covers	Page 3-10
Window Hardware	Page 3-11
Light Sconce Covers	Page 3-12



HB351 Single Arm Brace

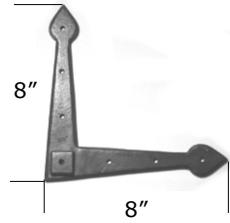

HB355 Corner Brace

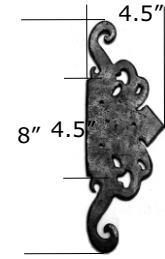

HB356 Scrolled Strap



HB357 Arrow head Strap

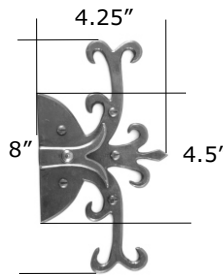

HB358 Chateau Strap



HB358L Chateau Long Strap

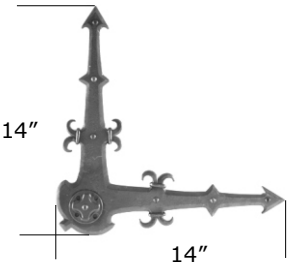

HB359 Pistoria Brace



HB365 Strap (also in 18"L)

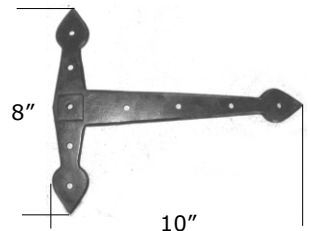

HB367 T-brace

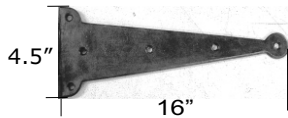

HB361D Strap

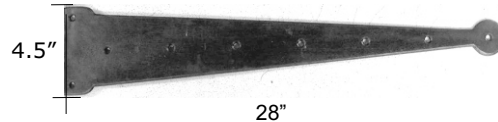

HB363D Strap



We offer full barrel and pintle strap hinges. Full barrel hinges are not handed. Pintle strap hinges are handed. Any strap hinge can be customized for size and style.

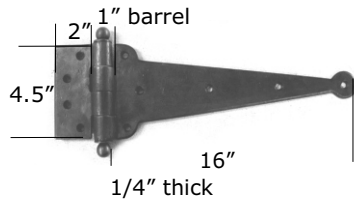

HB361 Full Barrel Heavy Duty Strap Hinge

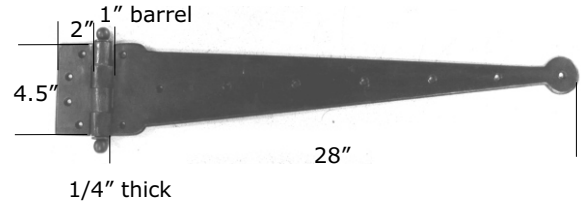

HB363 Full Barrel Heavy Duty Strap Hinge

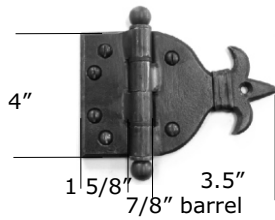

HB369 Full Barrel Fleur de Lis Strap Hinge



HB451 12" Bean Strap Hinge
HB452 18" Bean Strap Hinge
HB453 21" Bean Strap Hinge

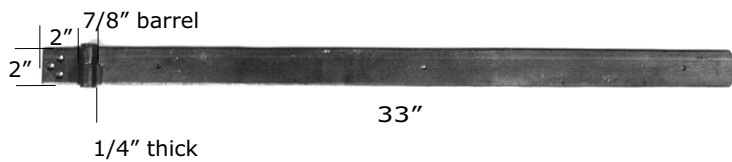

HB371 Pintle Strap Hinge. MUST SPECIFY HANDING (see handing chart on next page).

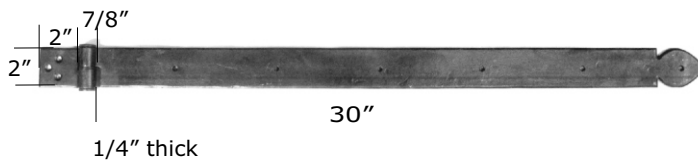

HB372 Pintle Strap Hinge. MUST SPECIFY HANDING (see handing chart on next page).



OUR HAND CRAFTED IRON HINGES ARE PINTLE (GRAVITY) HINGES. MUST SPECIFY HANDING.

STEEL HEAVY DUTY PINTLE DOOR HINGES (w/ teflon bushings)

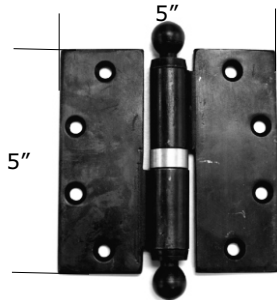

- SIZES:
- HN404 6" x 6" Pintle Hinge
 - HN405 5" x 5" Pintle Hinge
 - HN406 4.5" x 4" Pintle Hinge
 - HN408 4.5" x 4.5" Pintle Hinge

SPECIFICATIONS:

- 7/8" barrel diameter
- 3/16" leaf thickness

HN405 shown w/standard Ball finial. Also available with Acorn finial- please specify.

STEEL PINTLE CABINET HINGES

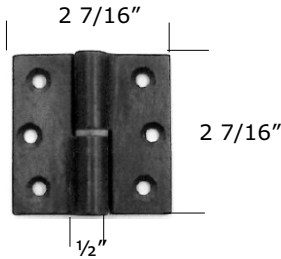

HNC110

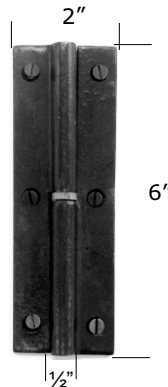

HNC150

DOOR HANDING GUIDE:

Door Handing is determined by standing at the outside of the door while facing the door. The side of the hinges determines door handing.

Regular In-swing Doors

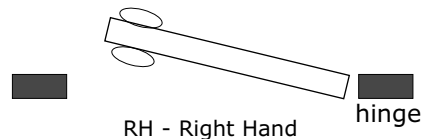
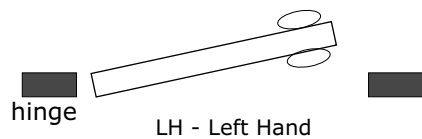

OUTSIDE

Out-swing Doors

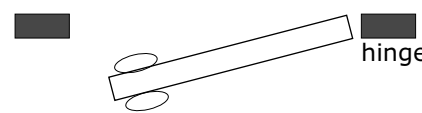
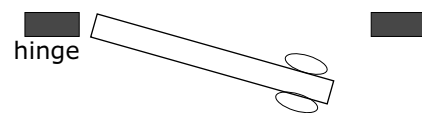

OUTSIDE

LHR - Left Hand Reverse

RHR - Right Hand Reverse

All rights reserved. Rev 1014



ALL SURFACE BOLTS COME WITH MORTISE STRIKE. SPECIFY SURFACE STRIKE

LEAF GRIP SURFACE BOLTS

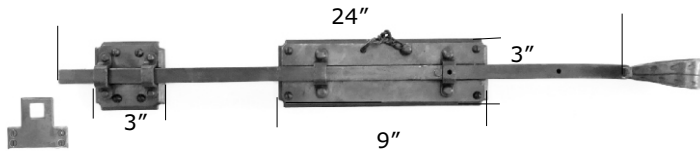

HB280 24" Surface Bolt

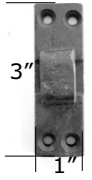

OPTIONAL SURFACE STRIKE

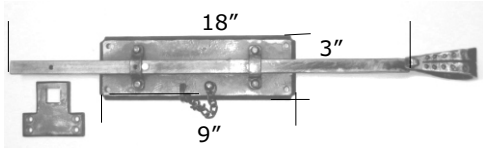

HB281 18" Surface Bolt

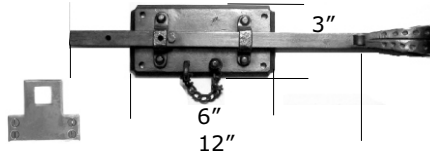

HB283 12" Surface Bolt

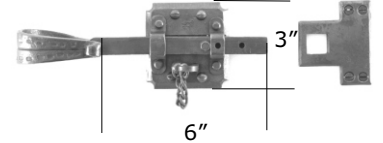

HB285 6" Surface Bolt

AVAILABLE WITH BALL GRIP - PLEASE SPECIFY

DUNN SURFACE BOLTS

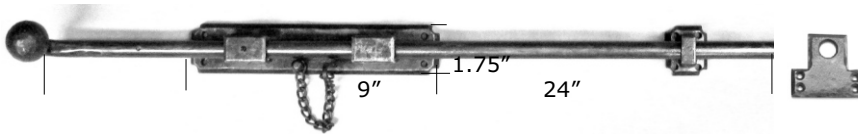

HB286 24" Dunn Surface Bolt

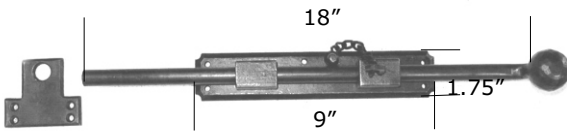

HB287 18" Dunn Bolt

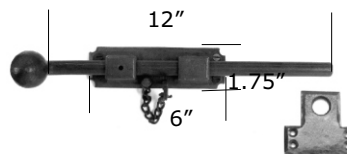

HB288 12" Dunn Bolt

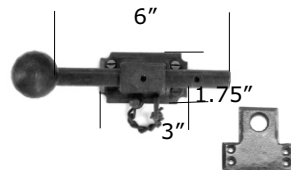

HB289 6" Dunn Bolt

NARROW GUIDE SURFACE BOLTS



HB274 24" Narrow Guide Bolt

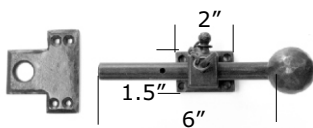

HB271 6" Narrow Guide Bolt
2.75" throw

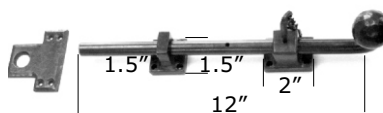

HB272 12" Narrow Guide Bolt

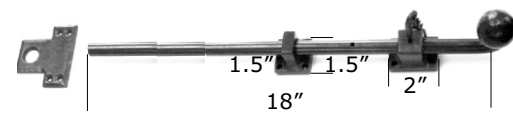

HB273 18" Narrow Guide Bolt

All rights reserved. Rev 0018

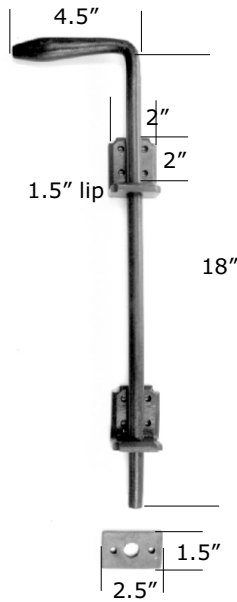

HB233 Cane Bolt

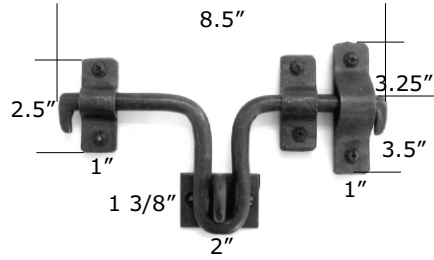

HB520 Slide Bolt
1 5/8" total projection

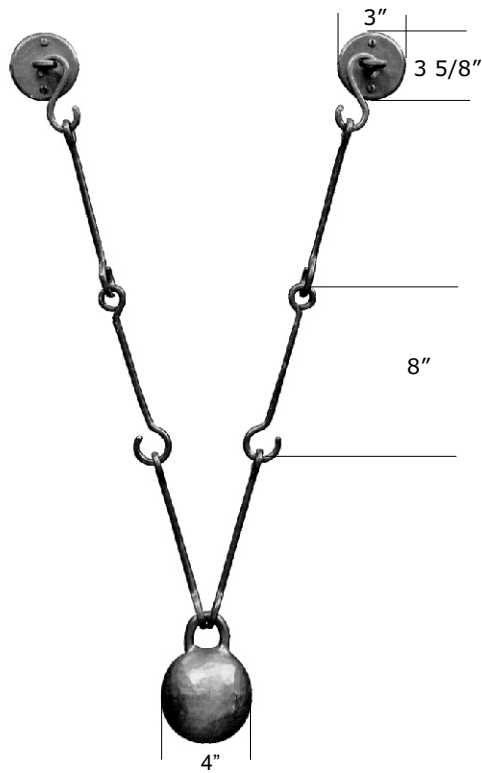

HGC600 Cannonball Gate Closer

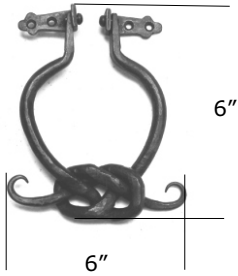

HD252 Knot

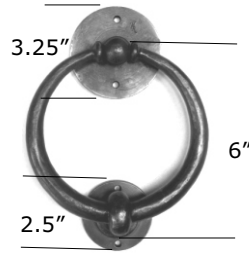

HD254 Ring

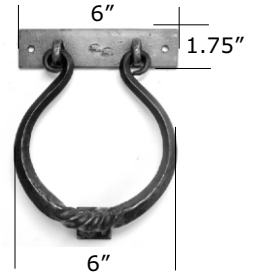

HD255 Twist



HD256 East-West

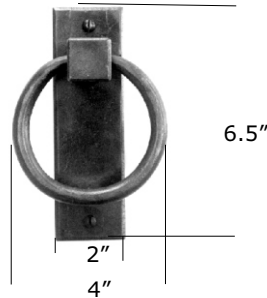

HD257 East-West II

KICK PLATES

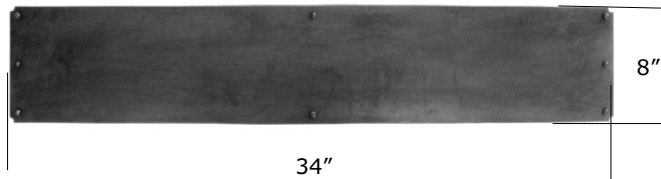

HKP810: 34" x 8" x 1/8"
Specify Straight Edge, Beveled (square corners), or Notched.

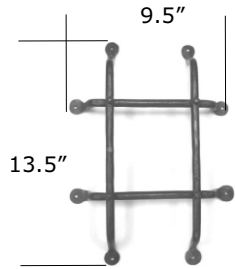

HG285

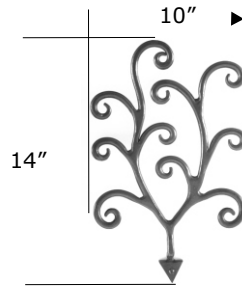

HG287 Chateau

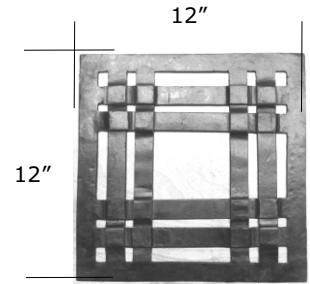

HG288 Craftsman

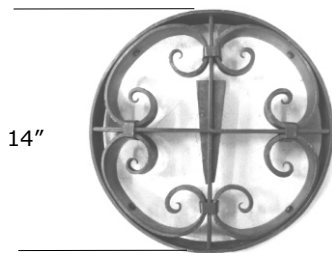

HG290 Quarterfoile

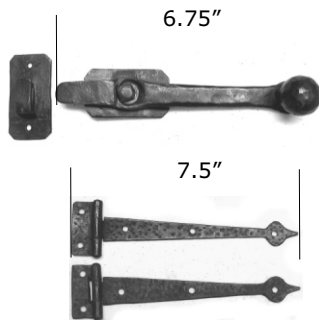

HG233 Latch & 2 Strap hinges

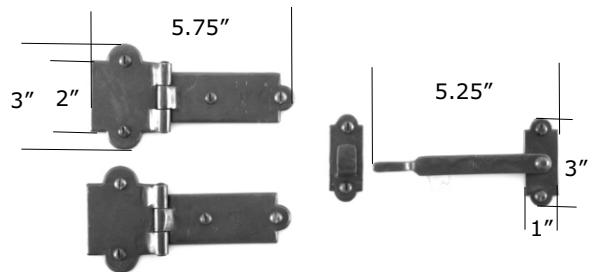

HG235 Arch Latch & 2 Strap hinges

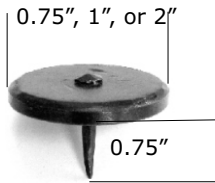

HC331 3/4" Round
HC332 1" Round
HC333 2" Round

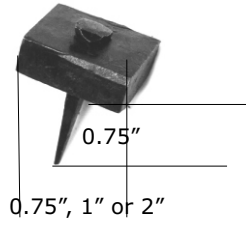

HC341 3/4" Square
HC342 1" Square
HC343 2" Square

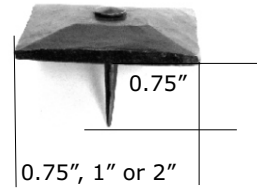

HC351 3/4" Pyramid
HC352 1" Pyramid
HC353 2" Pyramid

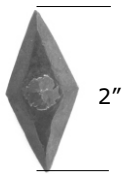

HC323 2" Diamond

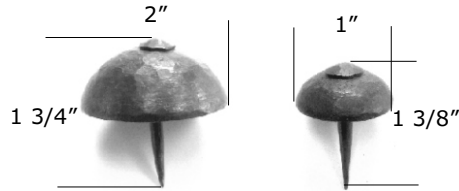

HC362 1" Dome
HC363 2" Dome



HN390 Square head split nail

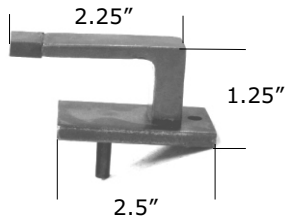

HD258 Contemporary Floor Stop

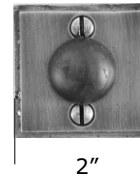

HD259 Wall Stop

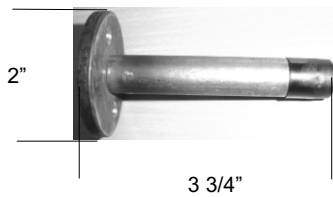

HD261 Base Door Stop

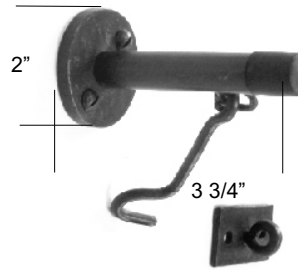

HD261W Base Door Stop w/hook



HD262 Floor Stop



HD262W Floor Stop w/hook

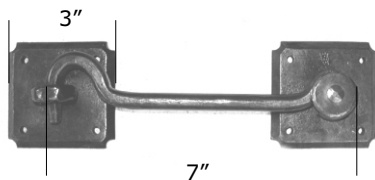

HB370L Large Hook & Eye

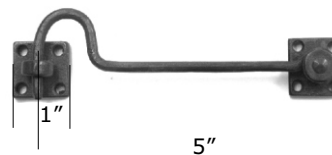

HB370S Small Hook & Eye



Any escutcheon can be made into a door bell button. The following are standard offerings. Please call for pricing for other styles.

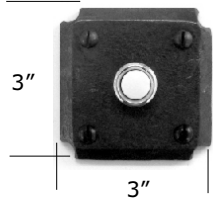

HE603-BB Notched

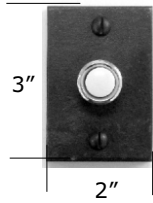

HE651-BB Straight Edge

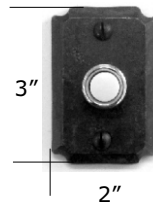

HE651NC-BB Notched

Also available: HE651B-BB Beveled

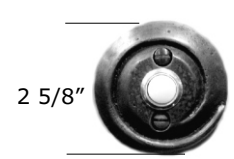

HE627-BB Art Nouveau

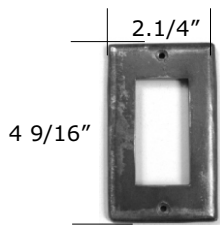

HSP1 Decora

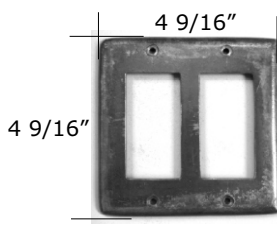

HSP2 Decora

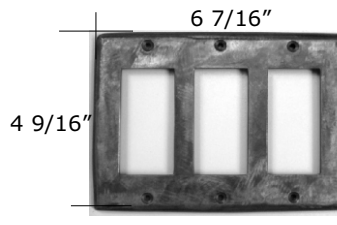

HSP3 Decora

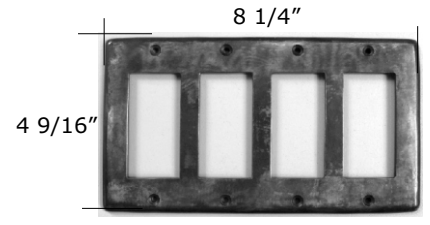

HSP4 Decora

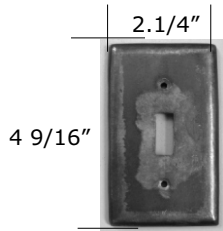

HSPS1 Switch

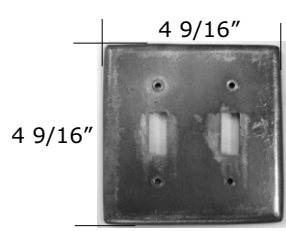

HSPS2 Switch

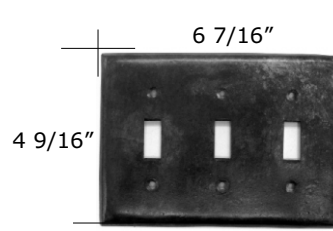

HSPS3 Switch

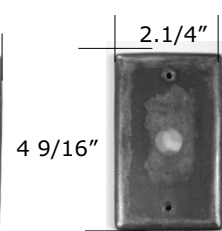

HSPC Cable

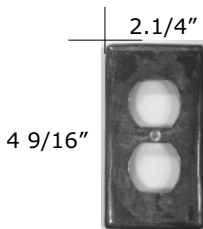

HOP1 Outlet

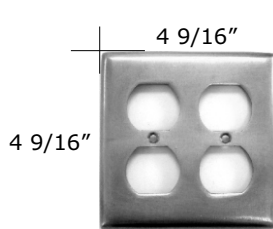

HOP2 Outlet

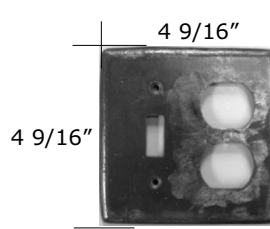

HSOP2 Combo Switch & Outlet

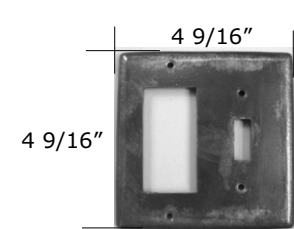

HSOP3 Combo Switch & Decora

Also available: HSPP Single Cover Plate 2 1/4" x 4 9/16"



EUROPEAN TILT & PUSH WINDOW HARDWARE

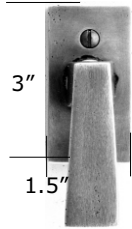

HE500-HL132M



HE500-HL137M



HE500-HL138M

HE500 1.5"x 3" Tilt & Push Escutcheon

Available with:

- HL131M Mini Accent Lever
- HL132M Mini Manhattan Lever
- HL121M Mini Verona Lever
- HL137M Mini Milan Lever
- HL103M Mini Casa California Lever
- HL113M Mini Scrolled Lever
- HL138M Mini Del Mar Levers

WE CAN MAKE ANY OF OUR LEVERS FOR WINDOWS

DOUBLE-HUNG WINDOW HARDWARE

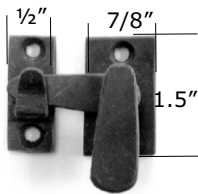

HW114 Sash Lock
MUST SPECIFY HANDING (showing RH)

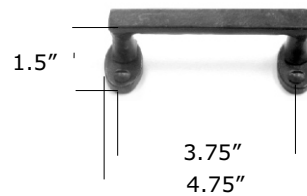

HW111 Front-mount Scottsdale Sash Pull

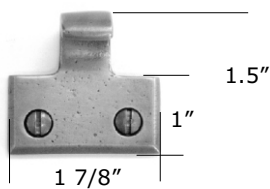

HW117 Sash Lift

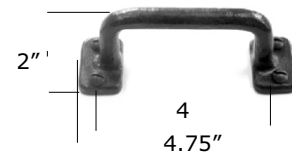

HW112 Front-mount Classic Sash Pull

CASEMENT WINDOW HARDWARE

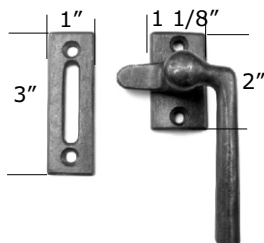

HW115 Casement Latch
MUST SPECIFY HANDING (showing RH)

(with standard Mortise Strike as shown)
SPECIFY SURFACE STRIKE if needed!



SCONCE COVER ONLY - DOES NOT INCLUDE ANY ELECTRICAL PARTS OR FITTINGS

HLT801 Louvre Sconce Cover

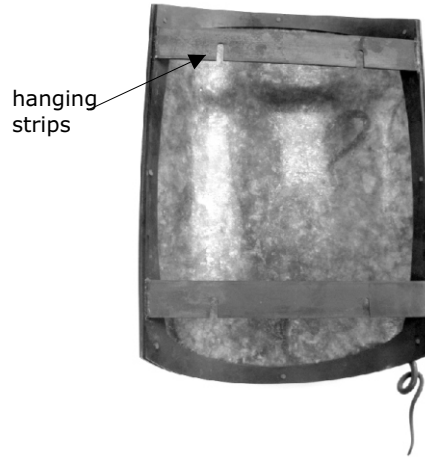
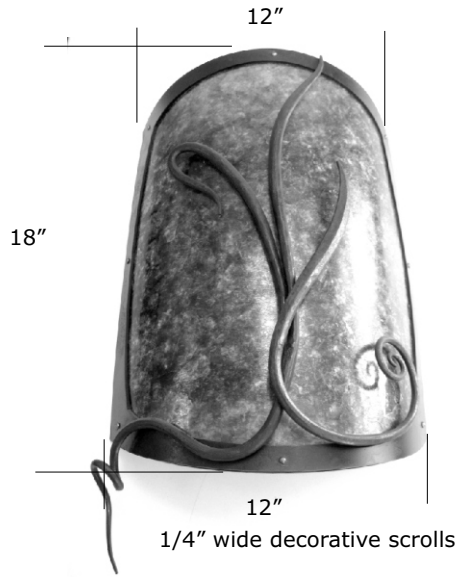



CONTENTS

This section contains a variety of pulls and knobs as well as bath hardware

Cabinet Pulls & Knobs	Page 4-1 / 4-7
European Ring Pulls	Page 4-8
Bath Hardware	Page 4-9 / 4-10

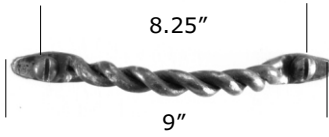

HP703 Rope



HP704 Rope



HP706S Trio
(w/ copper wire+bands)



HP765 Trio
(w/ copper wire+bands)

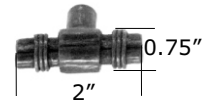

HP778 Trio T-knob
(w/ copper wire+bands)

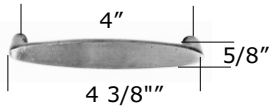

HP707SC-4 El Secreto

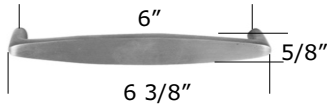

HP707SC-6 El Secreto



HP707SC-8 El Secreto

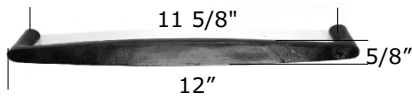

HP707SC-12 El Secreto

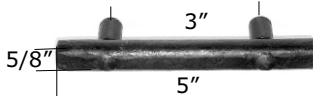

HP731 Rectangular

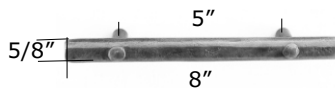

HP708-8 Rectangular

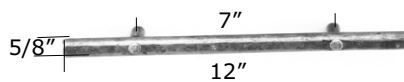

HP708-12 Rectangular

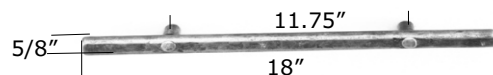

HP708-18 Rectangular

NOTE: MOST CABINET PULLS HAVE A 1 1/8" - 1 1/4" PROJECTION

All rights reserved. Rev 0118



HP720 Notched Ring Pull

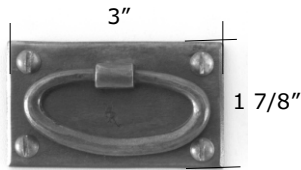

HP732 Bungalow



HP733 1" Round
HP734 2" Round

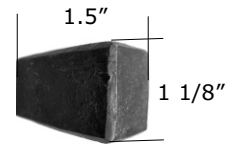

HP735 East-West

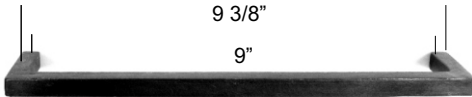

(3/8" square profile. HP726-9 shown)
HP726 Stockholm

- HP726-4: 4 3/8", 4" c-to-c
- HP726-6: 6 3/8", 6" c-to-c
- HP726-9: 9 3/8", 9" c-to-c
- HP726-12: 12 3/8", 12" c-to-c
- HP726-15: 15 3/8", 15" c-to-c
- HP726-24: 24 3/8", 24" c-to-c

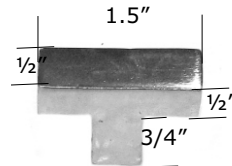

HP727 Stockholm T-knob

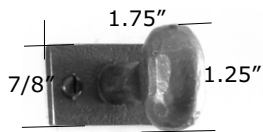

HP738 Melon

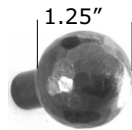

HP741 Forged Knob

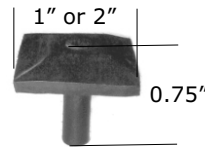

HP743 1" Pyramid
HP744 2" Pyramid



HP751 Aegean

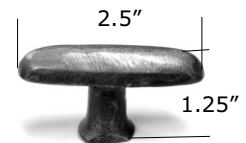

HP753 Oblong

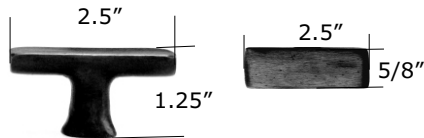

HP754 Scottsdale T-knob



HP754M Scottsdale 5"

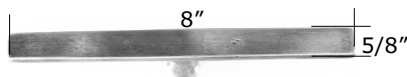

HP754L Scottsdale 8" Single Post

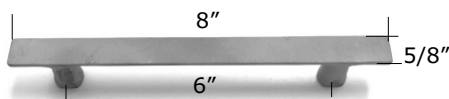

HP754DL-8 Scottsdale 8" Double Post

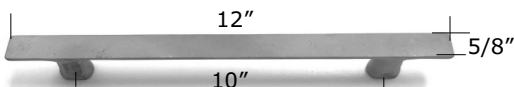

HP754DL-12 Scottsdale 12" Double Post

NOTE: MOST CABINET PULLS HAVE A 1 1/8" - 1 1/4" PROJECTION

All rights reserved. Rev 0118



HP758 Sunrise

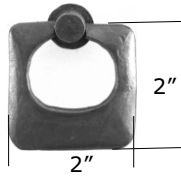

HP760 Tokyo Drop Pull



HP761 Bin Pull



HP762 Casa California

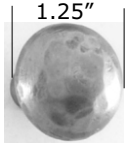

HP763 Mushroom

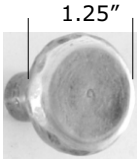

HP764 Martini

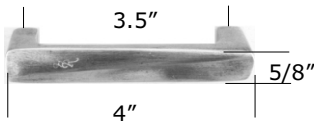

HP766-4 Milan

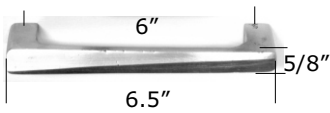

HP766-6 Milan

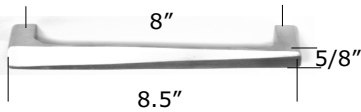

HP766-8 Milan

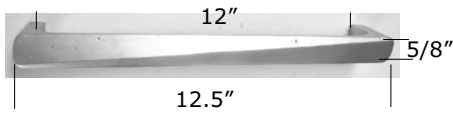

HP766-12 Milan

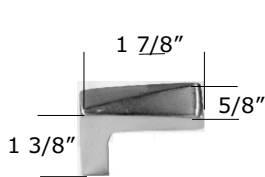

HP737 Milan L-shaped

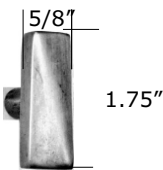

HP774 Milan Rectangular

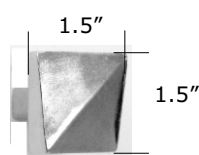

HP775 Milan Square

NOTE: MOST CABINET PULLS HAVE A 1 1/8" - 1 1/4" PROJECTION

All rights reserved. Rev 0118



HP767-4 Hampton

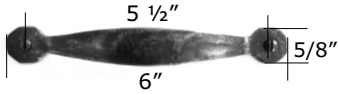

HP767-6 Hampton

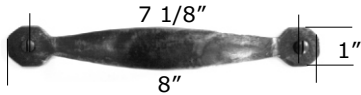

HP767-8 Hampton



HP767-12 Hampton



HP768 Casa California II
HP768L: 12" c-to-c, 13.25" total length

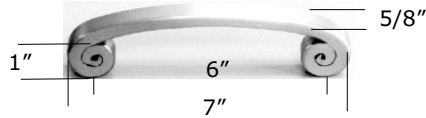

HP769 Casa California III

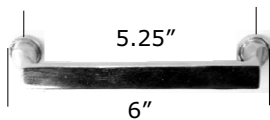

HP772-6 Prescott



HP772-8 Prescott

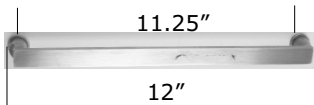

HP772-12 Prescott

NOTE: MOST CABINET PULLS HAVE A 1 1/8" - 1 1/4" PROJECTION

All rights reserved. Rev 0118

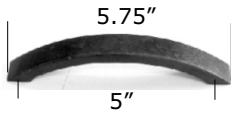

HP773-5 Arc



HP773-9 Arc



HP773-12 Arc



HP788-5 Twig

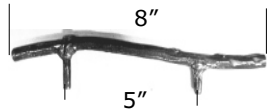

HP788-8 Twig



HP788-12 Twig



HP791-4 Monte Vista

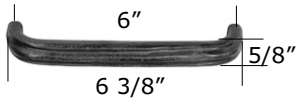

HP791-6 Monte Vista



HP791-8 Monte Vista

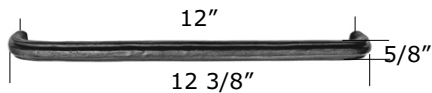

HP791-12 Monte Vista

NOTE: MOST CABINET PULLS HAVE A 1 1/8" - 1 1/4" PROJECTION

All rights reserved. Rev 0118

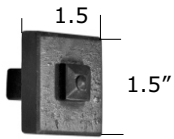

HP794 Cody Square



HP793-5 Cody



HP793-8 Cody

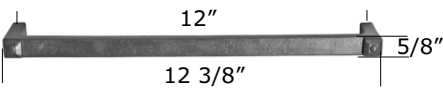

HP793-12 Cody



HP795-4 Avila

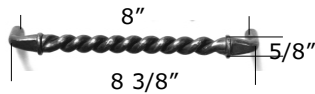

HP795-8 Avila

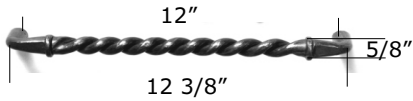

HP795-12 Avila

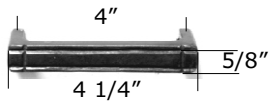

HP797-4 Sierra



HP797-8 Sierra



HP797-12 Sierra

NOTE: MOST CABINET PULLS HAVE A 1 1/8" - 1 1/4" PROJECTION

All rights reserved. Rev 0118

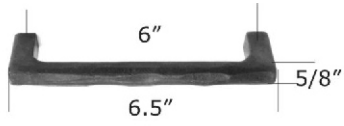

HP798-6 Dixon



HP798-8 Dixon



HP798-12 Dixon



HP799 Dixon



THESE DETAILED SPANISH STYLE RING PULLS CAN ALSO BE CUSTOMIZED - PLEASE INQUIRE FOR A QUOTE.

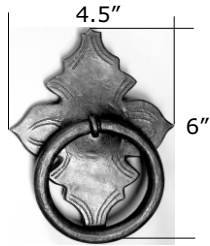

HP716 Catalonia

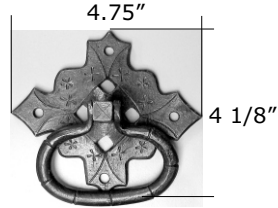

HP717 Seville

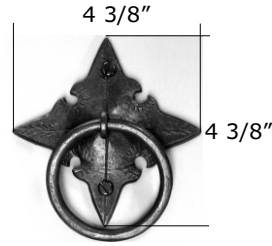

HP718P Merida

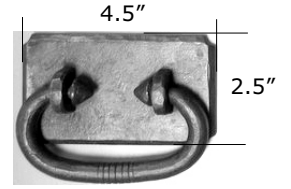

HP719 Guadalupe

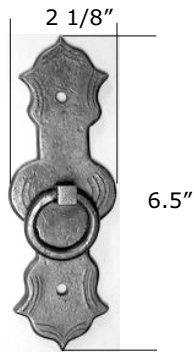

HP736 Veracruz

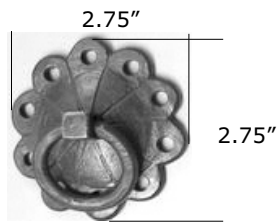

HP739 Baja

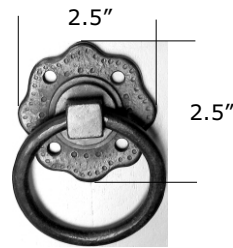

HP740 Monterey

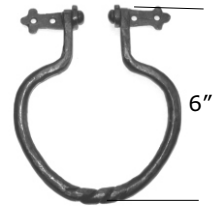

HP715 Twist



ROBE HOOKS

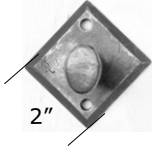

HT709 Diamond

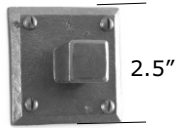

HT703 East-West



HT704 Casa California

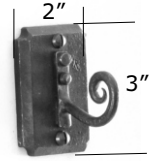

HT702 Scroll

TOILET PAPER HOLDERS

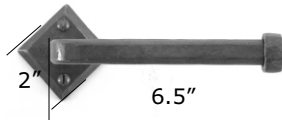

HT701 Diamond

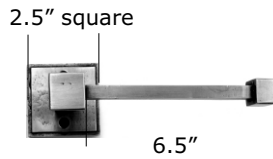

HT705 East-West

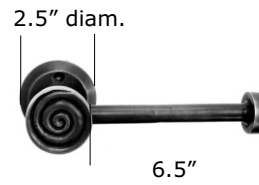

HT706 Casa California

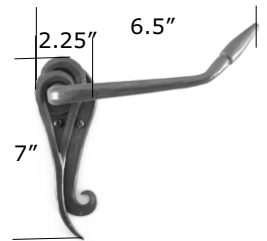

HT801 Art Nouveau

TOWEL RINGS

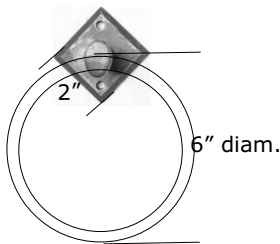

HT712 Diamond

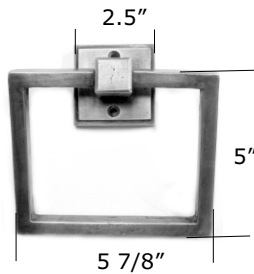

HT746 East-West

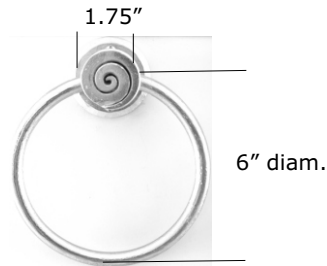

HT747 Casa California

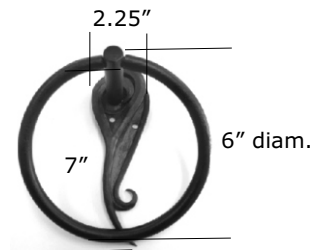

HT812 Art Nouveau



TOWEL BARS



Diamond Towel Bar

16" Length: HT716
24" Length: HT724
32" Length: HT732

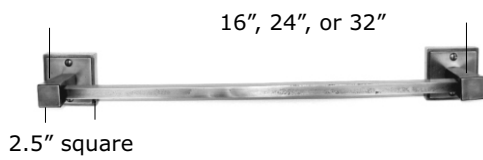

East-West Towel Bar

16": HT736
24": HT737
32": HT738



Casa California Towel Bar

16": HT756
24": HT757
32": HT758

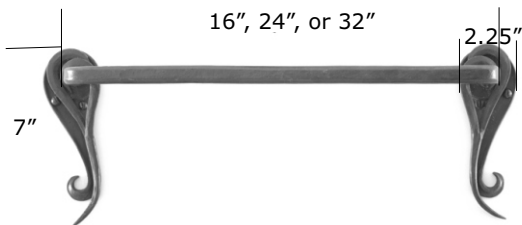

Art Nouveau Towel Bar

16" Length: HT816
24" Length: HT824
32" Length: HT832



HAND FORGED IRON HOSPITALITY KEYLESS ENTRIES

AVAILABLE FOR VING CARD OR SAFLOK. FULLY CUSTOMIZABLE. EXAMPLES SHOWN BELOW -CONTACT US!

INTERIOR SIDE

EXTERIOR SIDE

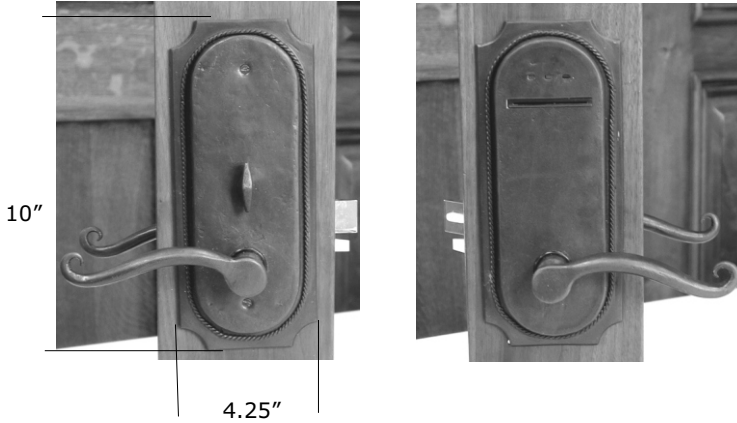

HE-401 Escutcheon shown with HL-113 Lever
(MT Select Lock)

MT SELECT LOCK: HE-401 Rope 4 1/2" x 10" Escutcheon
HE-402 Rivet 4 1/2" x 10" Escutcheon

MT LOCK: HE-403 Rectangular 3 3/8" X 10" Escutcheon

SEE SECTION E FOR LEVER OPTIONS
(SOME LEVERS NOT AVAILABLE WITH THIS ENTRY)



HE-403 Escutcheon shown with HL-102 Lever
(MT Lock)

FOR OTHER KEYLESS OPTIONS PLEASE ENQUIRE WITH US

FOR QUALIFYING HOSPITALITY PROJECTS, CERTAIN
CUSTOM DESIGNS ARE AVAILABLE WITHOUT AN UPCHARGE.
CHECK WITH YOUR HARDWARE RENAISSANCE DEALER
FOR DETAILS.



SOLID BRONZE HARDWARE

All rights reserved. Rev 1014

3205A Mercantile Court, Santa Fe NM 87507 USA

Tel 505.983.2644 Fax 505.820.2941 sales@hardwarerenaissance.com www.hardwarerenaissance.com



SOLID BRONZE PATINAS

HARDWARE PRICE INCLUDES CHOICE OF ANY OF THE FOLLOWING HAND APPLIED PATINAS:

PATINA NAME PATINA CODE

SILICON BRONZE BASE ALLOY

Midnight Gold:	MG
Cascade Green:	CG
Antique Gold:	AN
Red Autumn Leaves:	RL
Sonora Red:	SR
French Brown:	FB
Granite Verde:	GV
Tuscan Bronze:	TB
Old Copper:	OC
Navajo Silver:	NS
Khaki:	KH
Obsidian:	ON
Brushed Bronze:	BB

WHITE BRONZE BASE ALLOY

Natural White:	NW
Pewter White:	PW
Midnight White:	MW

IMPORTANT NOTE ABOUT OUR BRONZE PATINAS:

All patinas are hand applied and will vary slightly from patina samples or display samples. This is due to aging of samples, and natural variations in patina which occur depending upon the bronze casting, and temperature and humidity while applying the patina. This is considered to be a key part of the beauty and uniqueness of our hand crafted product and not a defect.

All our patinas are living finishes and will age gracefully over time. How quickly they will age depends upon the conditions of use and maintenance (a light re-waxing).

All rights reserved. Rev 0414



CONTENTS

This section contains all types of sets for entry or other exterior doors

BRONZE LEVER & KNOB OPTIONS	Page L1 - L2
Thumbblatch w/lever or Knob Entry sets	Page 6-1 / 6-4
Thumbblatch w/ Strike-bar Latch Entry sets	Page 6-5
Thumbblatch Entry Sets	Page 6-6 / 6-9
Fixed Grip Deadbolt Entry sets	Page 6-10
Lever or Knob Entry sets	Page 6-11 / 6-13
Lever or Knob Sectional Deadbolt Entry sets	Page 6-14 / 6-16
Deadbolts Only	Page 6-17
Strike-bar Latch Entry sets	Page 6-18
Multipoint Hardware	Page 6-19 / 6-25
Sliding Door Hardware	Page 6-26 / 6-28
Lift & Slide Hardware	Page 6-29

DOOR HANDING GUIDE:

Door Handing is determined by standing at the outside of the door while facing the door. The side of the hinges determines door handing.

Regular In-swing Doors



Out-swing Doors





SOLID BRONZE LEVERS & KNOBS



BL101 Verona

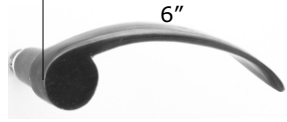

BL102 Soho



BL103 Casa California

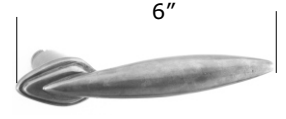

BL105 Art Deco



BL107 Neha

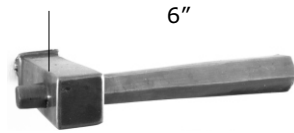

BL108 East-West

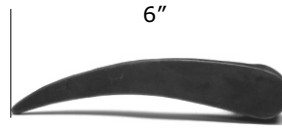

BL109 Fleetwood



BL110 Eagle Eye

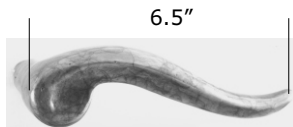

BL112 Dophin



BL131 Accent

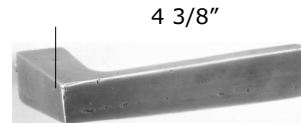

BL132 Manhattan



BL135 Verona II



BL136 Capri



BL137 Milan



BL138 Del Mar



BL139 Chelsea

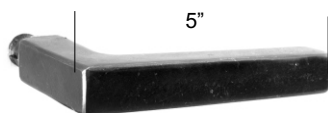

BL140 Bay

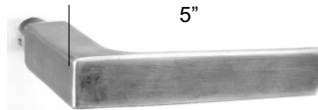

BL141 Scottsdale



BL142 Taos



BL143 Toscana

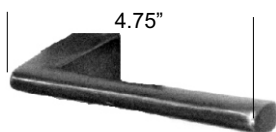

BL145 Salon



BL146 Fleur de Lis



BL147 Taylor Lever

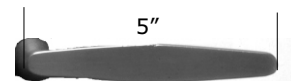

BL155 El Secreto Lever
All rights reserved. Rev 0118



SOLID BRONZE LEVERS & KNOBS



BL159 Alcott Lever

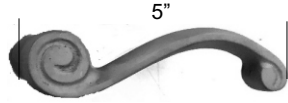

BL164 Dauphine Lever

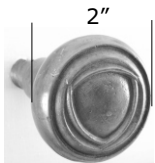

BK201 Art Deco Round

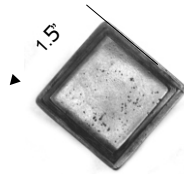

BK202 Art Deco Square



BLK203 Casa California

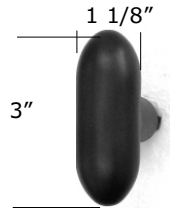

BK204 East-West



BK205 Sunrise

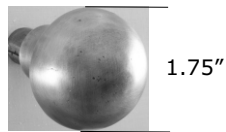

BK206 Mushroom

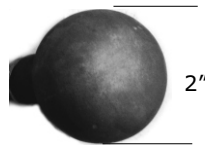

BK207 Ball Knob

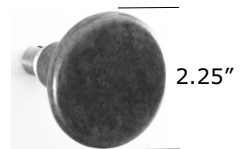

BK208 Martini

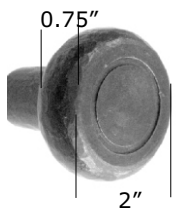

BK209 Hampton

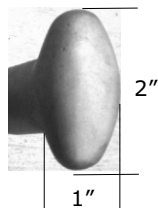

BK210 Eagle Eye

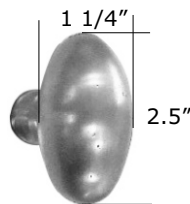

BK212 Bermuda

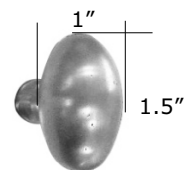

BK212S Petite Bermuda

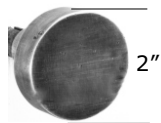

BK214 Eclipse

All rights reserved. Rev 1014



SOLID BRONZE ENTRY SETS

THUMBLATCH W/LEVER OR KNOB ENTRY SETS

WITH MORTISE LOCK. AVAILABLE WITH ANY LEVER OR KNOB ON INTERIOR SIDE.
(Can combine with interior escutcheons other than match ones shown)

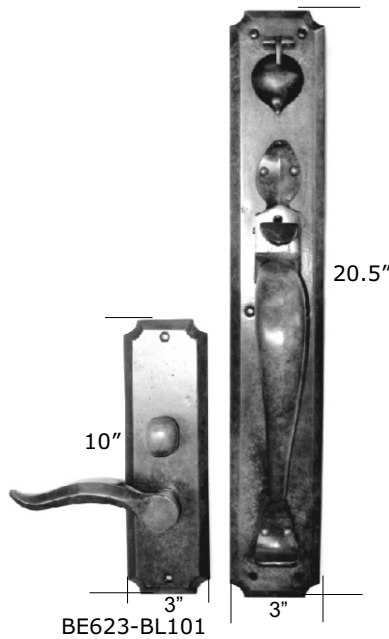

BH441 Normandy

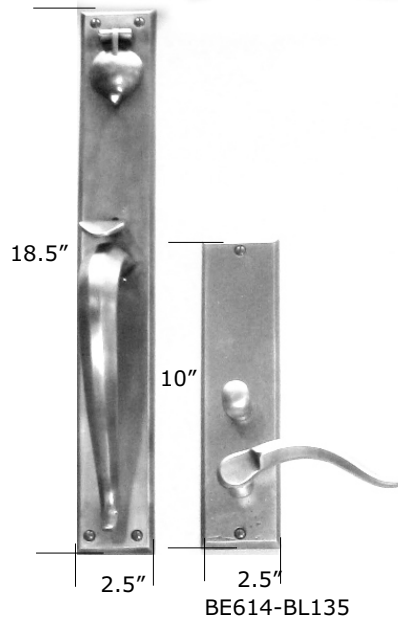

BH443 Verona

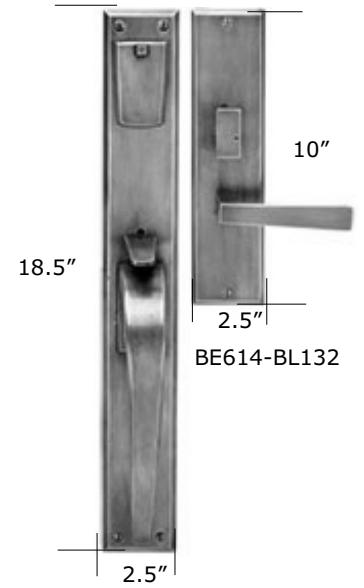

BH444 Manhattan

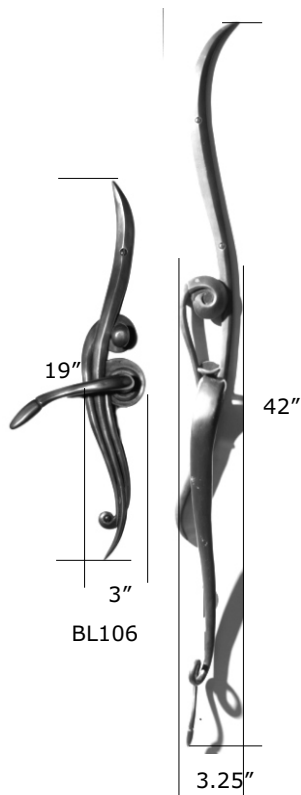

BH445 Louvre

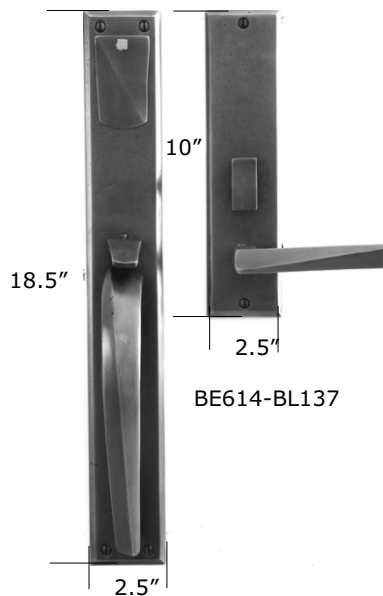

BH446 Milan

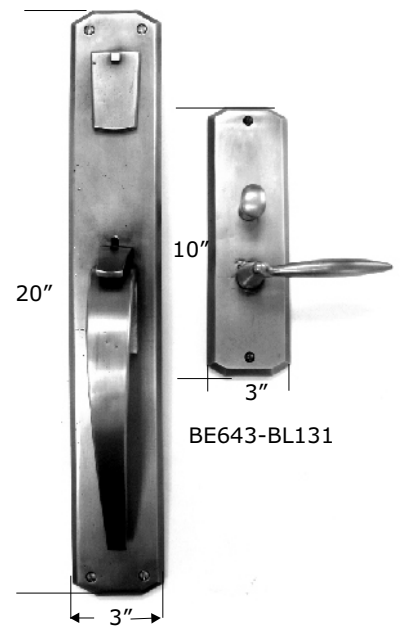

BH447 Skewed Corner

All rights reserved. Rev 1014



SOLID BRONZE ENTRY SETS

THUMBLATCH W/LEVER OR KNOB ENTRY SETS

WITH MORTISE LOCK. AVAILABLE WITH ANY LEVER OR KNOB ON INTERIOR SIDE.
(Can combine with interior escutcheons other than match ones shown)

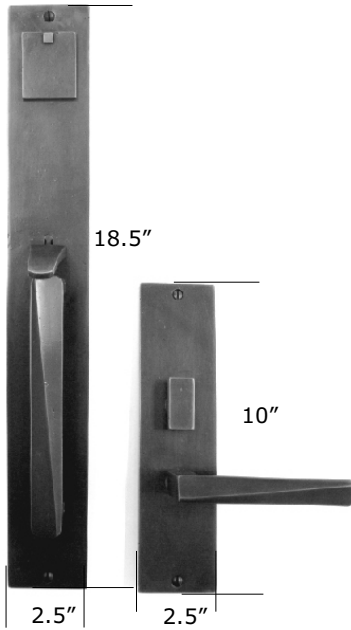

BE676-BL137

BH448 Milan II

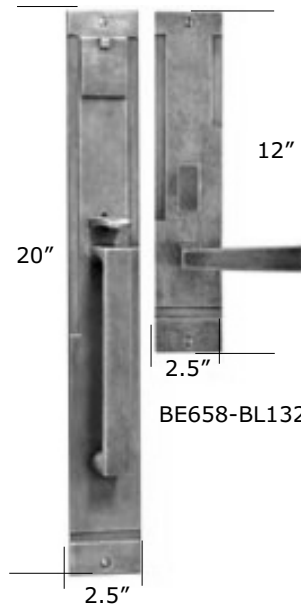

BE658-BL132

BH449 Tribeca

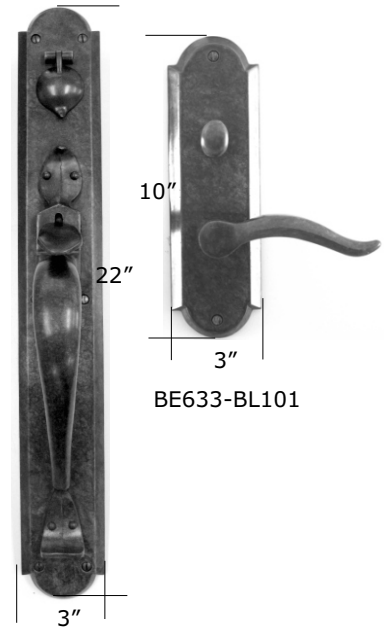

BE633-BL101

BH450 Arch

AVAILABLE AS SHOWN ONLY.

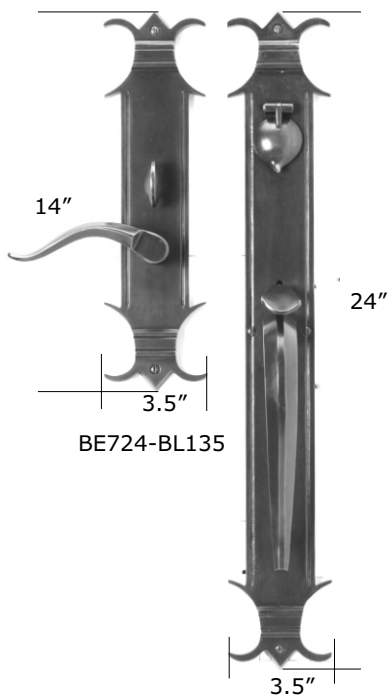

BE724-BL135

BH455 Chateau

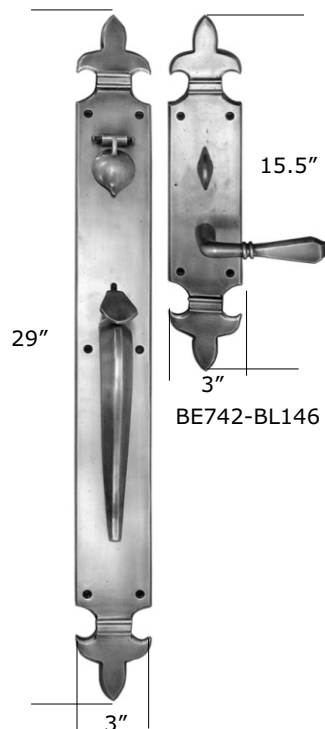

BE742-BL146

BH456 Fleur de Lis

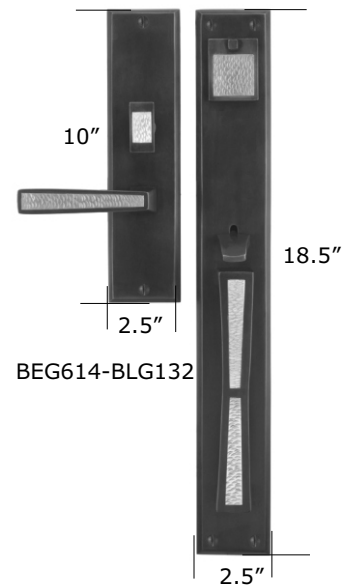

BEG614-BLG132

BHG461 Grande Manhattan
(w/textured bronze inlay)

All rights reserved. Rev 1014



SOLID BRONZE ENTRY SETS

THUMBLATCH W/LEVER OR KNOB ENTRY SETS

THESE ARE OUR NEW CURATED SERIES & ARE AVAILABLE AS SHOWN ONLY. AVAILABLE WITH MORTISE LOCK (EN-ML) ONLY.

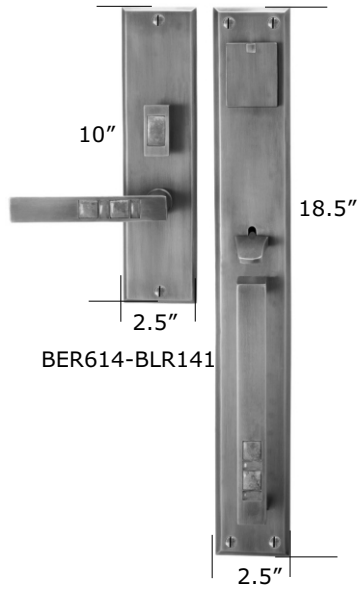

BER614-BLR141

BHR462 Scottsdale Royale
(w/optional semi-precious stone inlay)

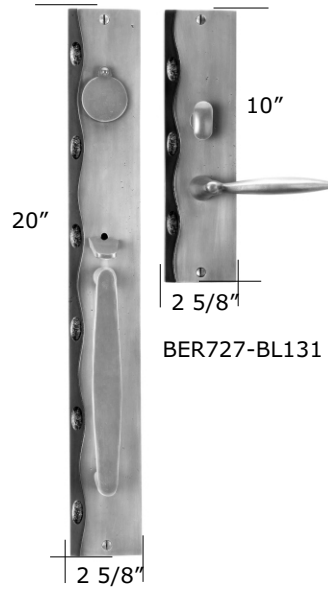

BER727-BL131

BHR464 Cayman Royale
(w/optional semi-precious stone inlay)

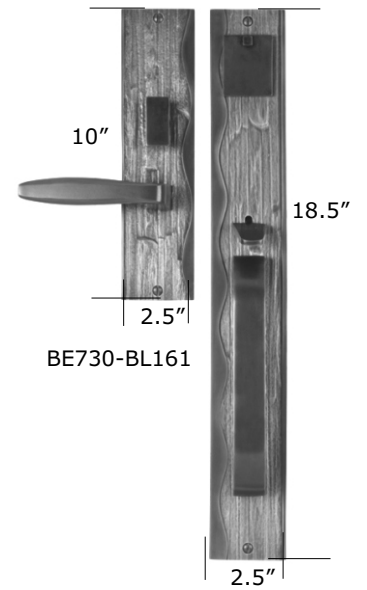

BE730-BL161

BH465 Amalfi

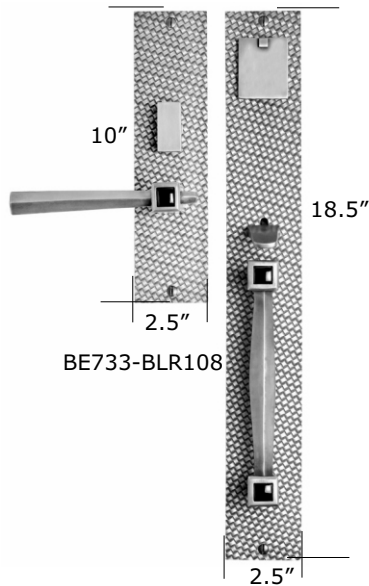

BE733-BLR108

BHR466 Amora Royale
(w/optional semi-precious stone inlay)

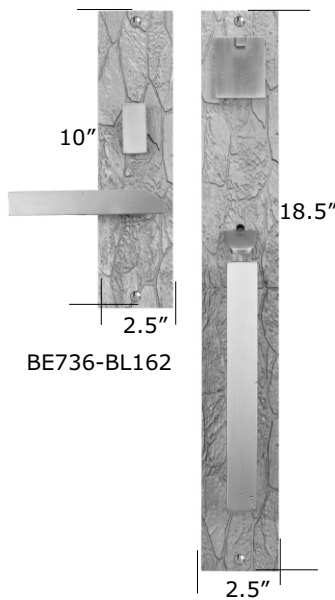

BE736-BL162

BH467 Canyon

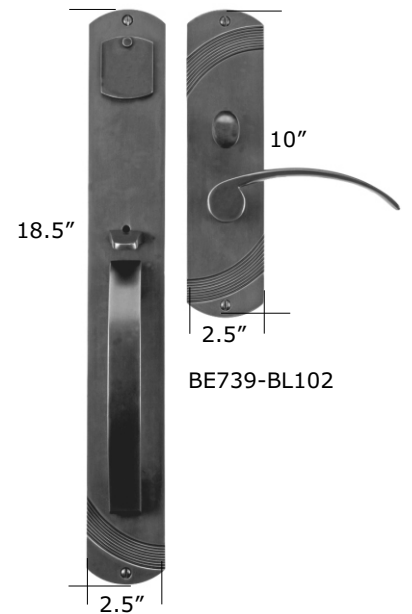

BE739-BL102

BH468 Greco

All rights reserved. Rev 1014



THESE ARE OUR NEW CURATED SERIES & ARE AVAILABLE AS SHOWN ONLY. AVAILABLE WITH MORTISE LOCK (EN-ML) ONLY.

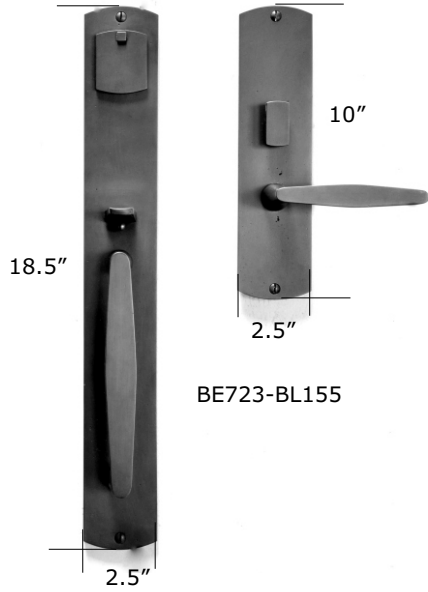

BE723-BL155

BH451 El Secreto



SOLID BRONZE ENTRY SETS

THUMBLATCH W/STRIKE-BAR LATCH ENTRY SETS

WITH MORTISE DEADBOLT. FOR INSWING DOORS. EXTENDED BAR IS THE LATCH - PARTIAL MORTISE STRIKE INCLUDED.

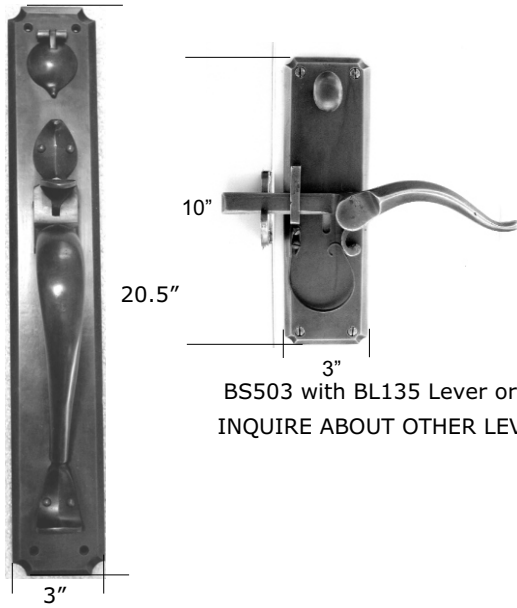

BS503 with BL135 Lever or BL101 Lever
INQUIRE ABOUT OTHER LEVER OPTIONS AT UPCHARGE

BH441 Normandy

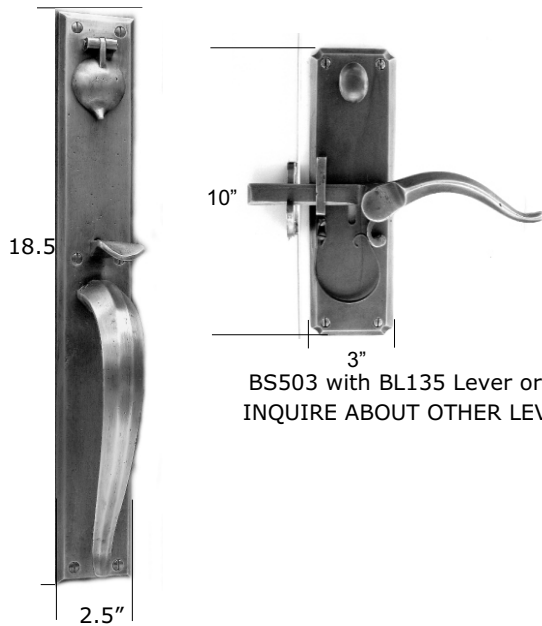

BS503 with BL135 Lever or BL101 Lever
INQUIRE ABOUT OTHER LEVER OPTIONS AT UPCHARGE

BH443 Verona



WITH MORTISE LOCK

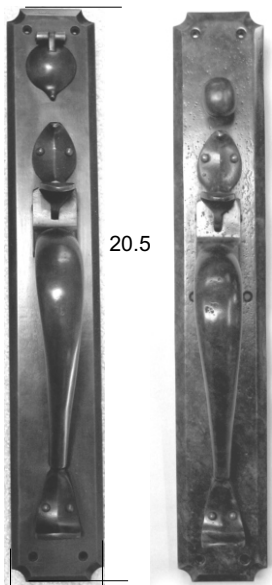

BH441 Normandy

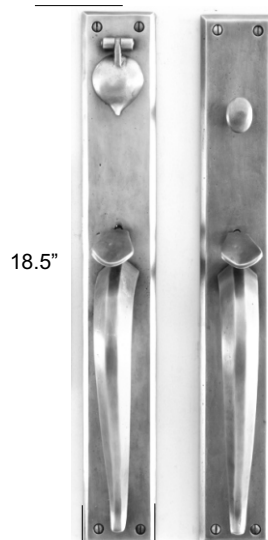

BH443 Verona

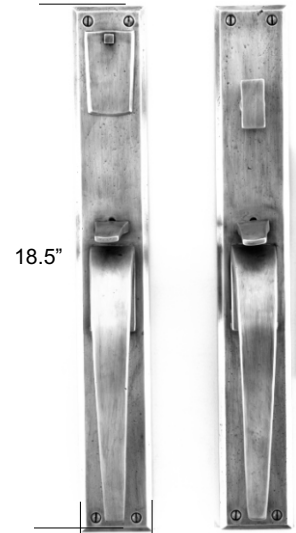

BH444 Manhattan

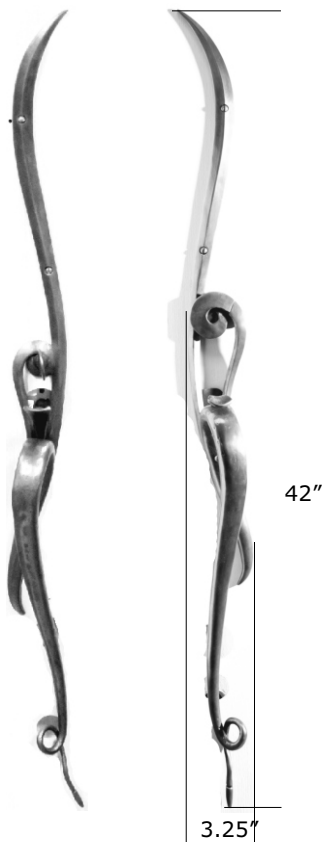

BH445 Louvre

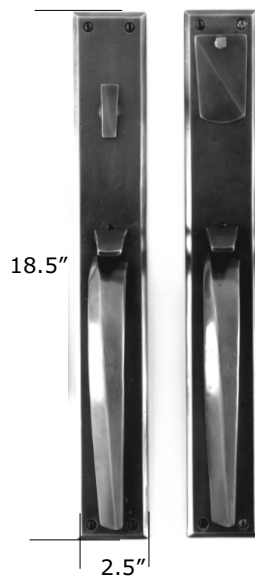

BH446 Milan

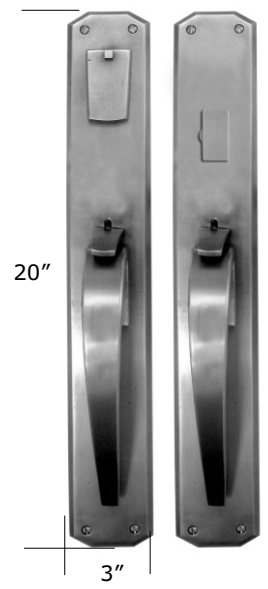

BH447 Skewed Corner



WITH MORTISE LOCK

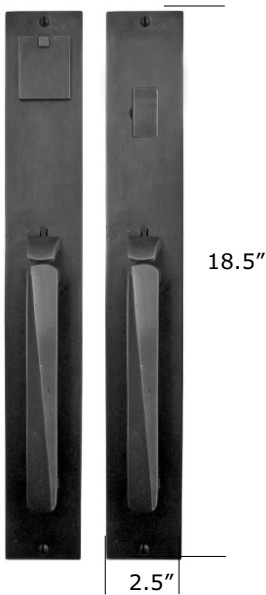

BH448 Milan II

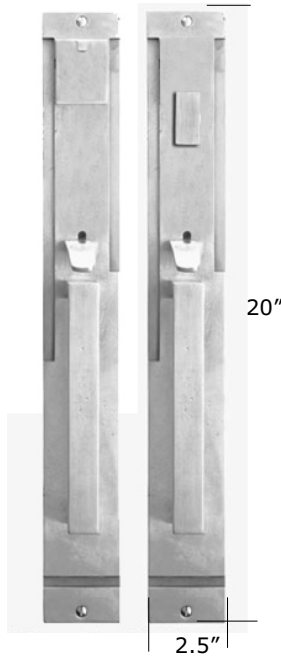

BH449 Tribeca

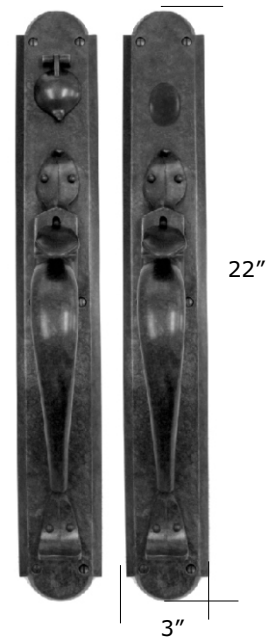

BH450 Arch

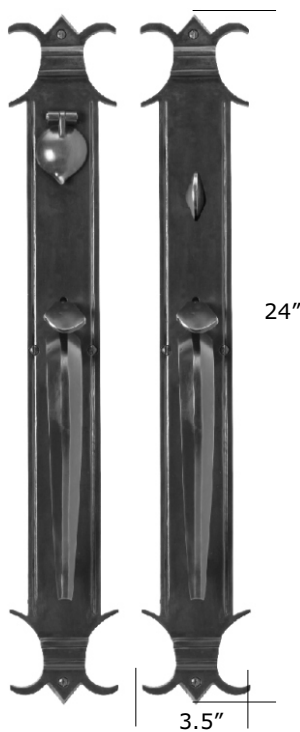

BH455 Chateau

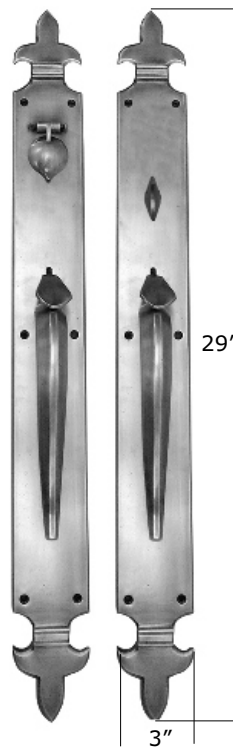

BH456 Fleur de Lis

AVAILABLE AS SHOWN ONLY.

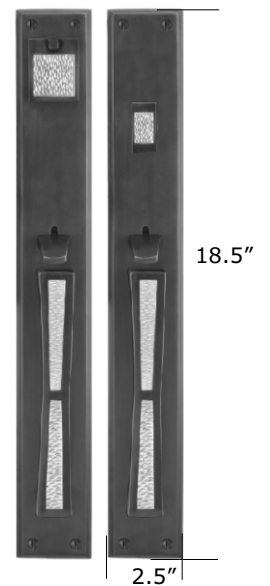

BH461 Grande Manhattan
(w/textured bronze inlay)

All rights reserved. Rev 1014



THESE ARE OUR NEW CURATED SERIES & ARE AVAILABLE AS SHOWN ONLY. AVAILABLE WITH MORTISE LOCK (EN-ML) ONLY.

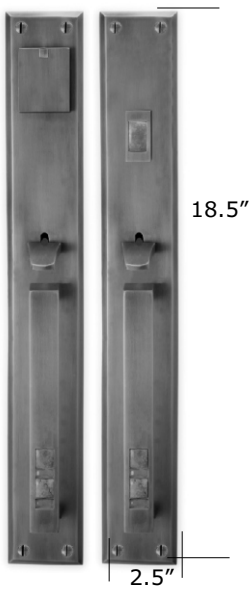

BHR462 Scottsdale Royale
(w/optional semi-precious stone inlay)

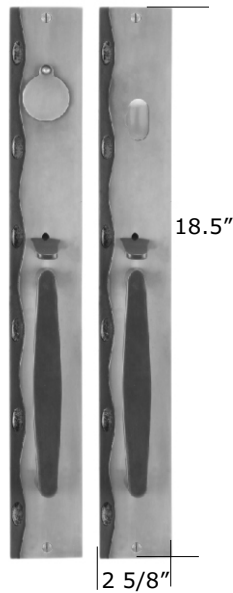

BHR464 Cayman Royale
(w/optional semi-precious stone inlay)

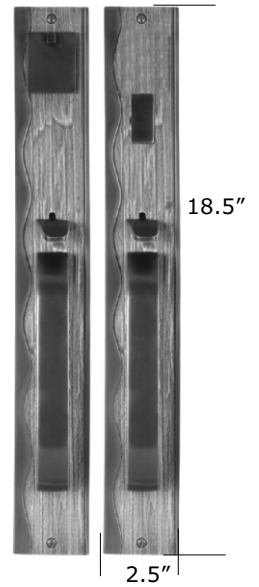

BH465 Amalfi

18.5"

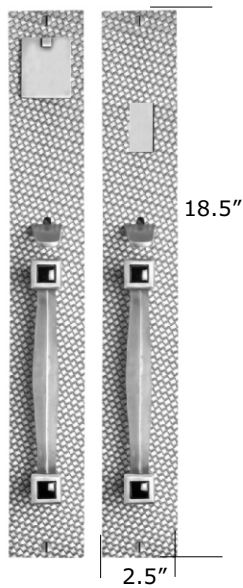

BHR466 Amora Royale
(w/optional semi-precious stone inlay)

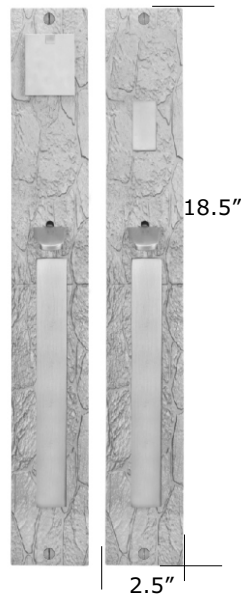

BH467 Canyon

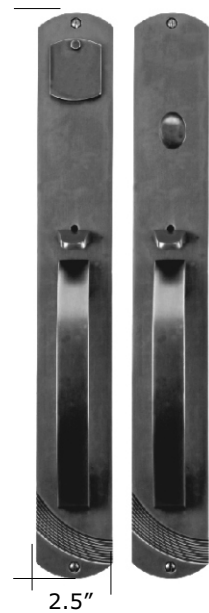

BH468 Greco

MORTISE LOCK ONLY

All rights reserved. Rev 1014



THESE ARE OUR NEW CURATED SERIES & ARE AVAILABLE AS SHOWN ONLY. AVAILABLE WITH MORTISE LOCK (EN-ML) ONLY.

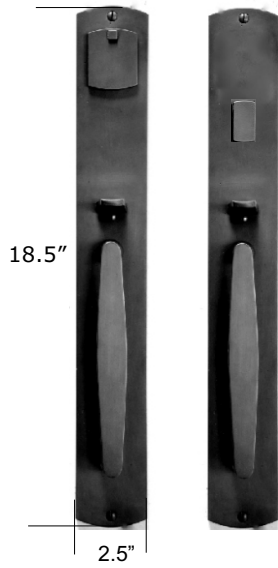

BH451 El Secreto



FIXED GRIP SETS AVAILABLE WITH TUBULAR DEADBOLT (EN-DB) OR MORTISE DEADBOLT (EN-MD)



BP106 Art Nouveau

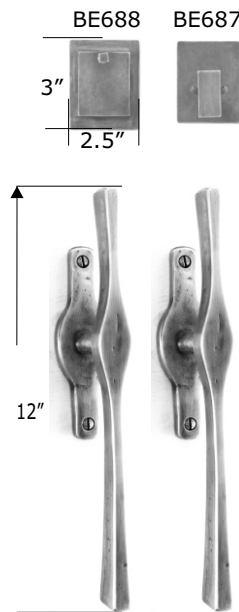

BP705 East-West
(3.5" projection)

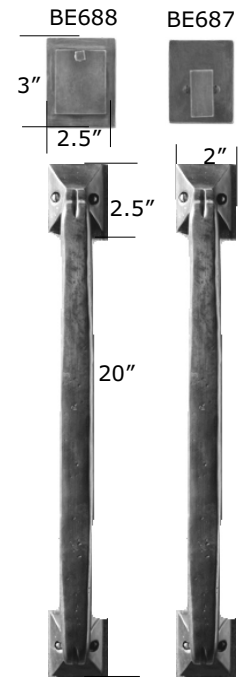

BP707L El Secreto
(2.5" projection)

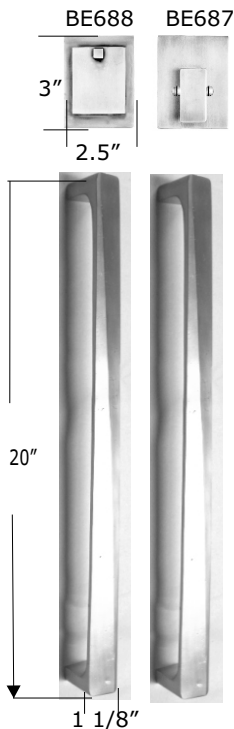

BP725L-20 Milan
(2" projection)

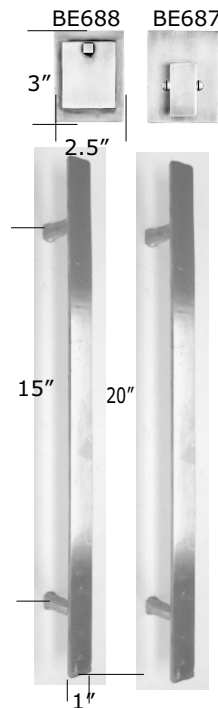

BP754L-20 Scottsdale
(2" projection)

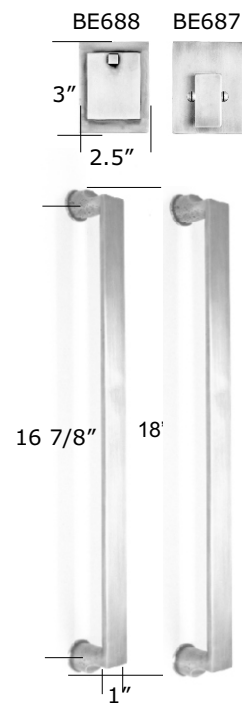

BP772AP-18 Prescott
(2" projection)

All rights reserved. Rev 1014



SOLID BRONZE ENTRY SETS

LEVER OR KNOB ENTRY SETS

AVAILABLE WITH MORTISE LOCK (EN-ML) OR TUBULAR DEADBOLT (EN-DB). AVAILABLE WITH ANY LEVER OR KNOB. (Tubular Deadbolt is made with 5.5" center-to-center unless specified).

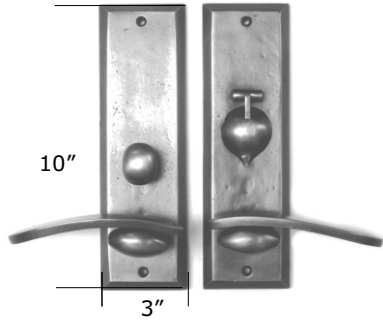

BE613 Traditional Beveled (shown w/BL110)

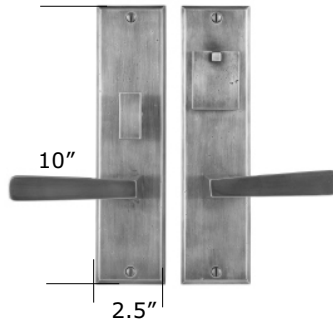

BE614 Beveled (shown w/BL132)

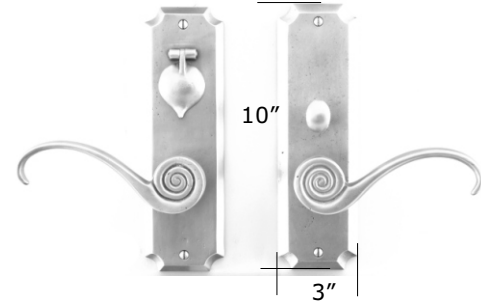

BE623 Notched Corner (shown w/BL103)

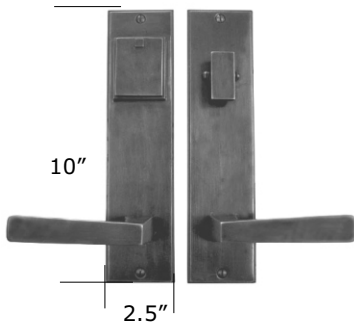

BE627 Step (shown w/BL132)

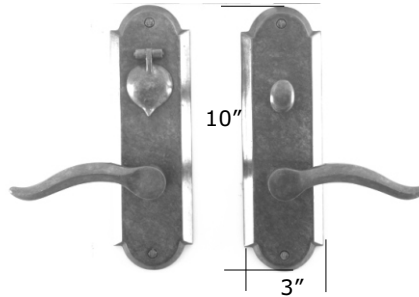

BE633 Arch (shown w/BL101)

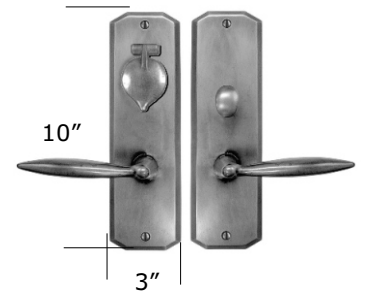

BE643 Skewed Corner (shown w/BL131)

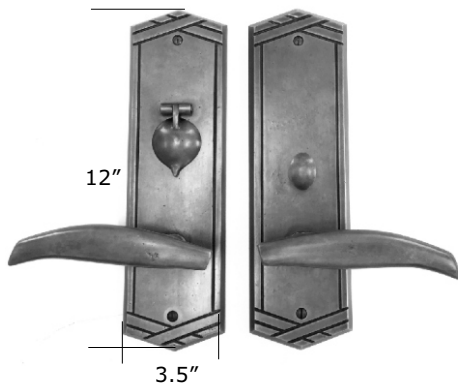

BE653 Chevron (shown w/BL107)

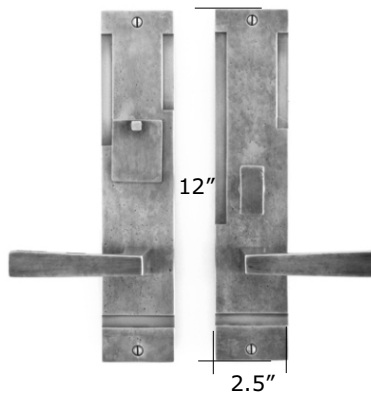

BE658 Tribeca (shown w/BL132)

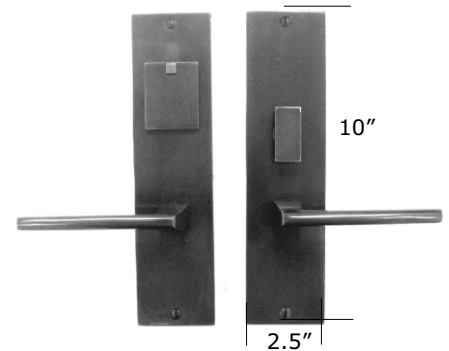

BE669 East-West (hidden step) (shown w/BL145)

All rights reserved. Rev0118



AVAILABLE WITH MORTISE LOCK (EN-ML) OR TUBULAR DEADBOLT (EN-DB). AVAILABLE WITH ANY LEVER OR KNOB. (Tubular Deadbolt is made with 5.5" center-to-center unless specified).

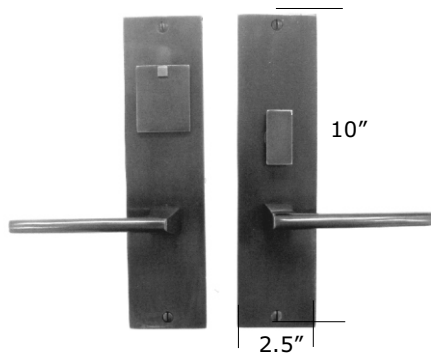

BE676 Manhattan (shown w/BL145)

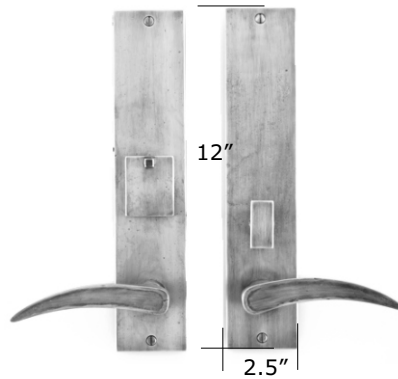

BE677 Manhattan (shown w/BL108)

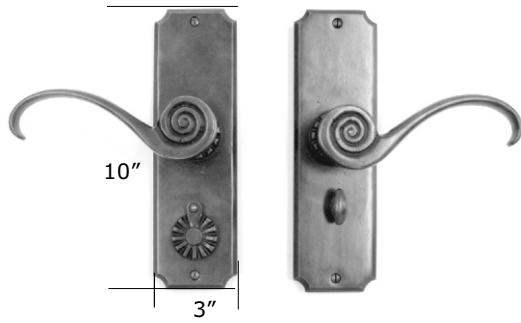

BE691L Rosette w/BL103 (Deadbolt 3 5/8" c-to-c only)

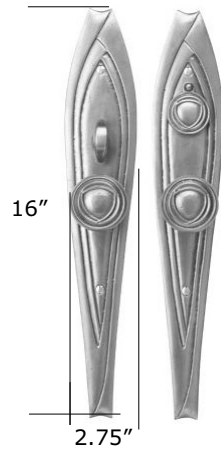

BE692 Art Deco w/BK201 (Mortise only)

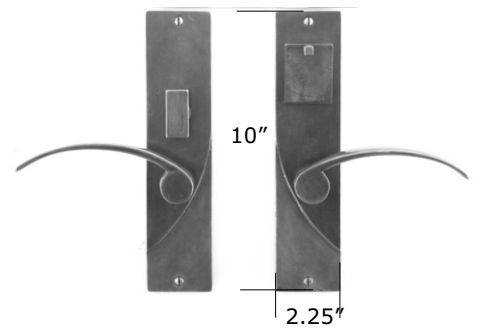

BE696 Art Nouveau II w/BL102 (Deadbolt 3 5/8" c-to-c only)



BL106 Louvre (Mortise only)

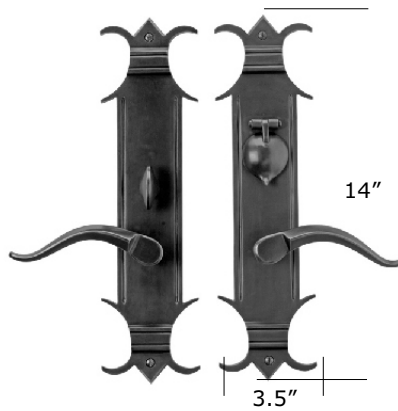

BE724 Chateau (Mortise only)

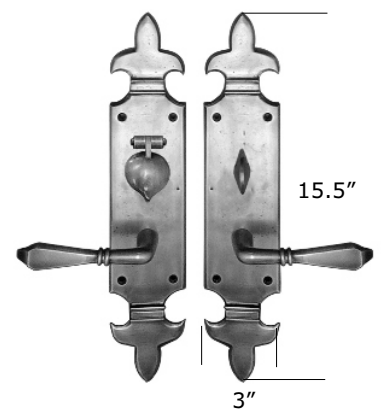

BE742-BL146 Fleur de Lis (Mortise only)

All rights reserved. Rev 1014



THESE ARE OUR NEW CURATED SERIES & ARE AVAILABLE AS SHOWN ONLY. AVAILABLE WITH MORTISE LOCK (EN-ML) ONLY.

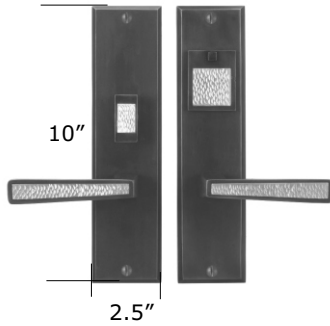

Grande Manhattan w/bronze inlay
BEG614-BLG132

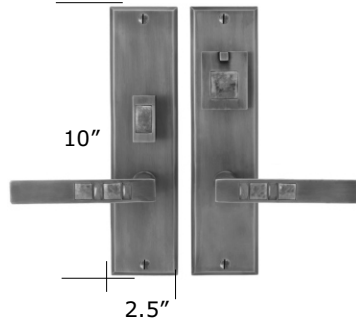

Scottsdale Royale
w/optional semi-precious stone inlay
BER614-BLR141

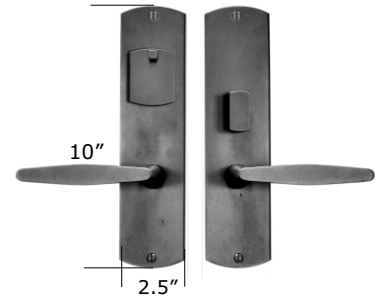

El Secreto
BE723-BL155

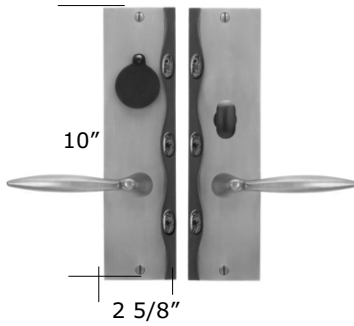

Cayman Royale
w/optional semi-precious stone inlay
BER727-BL131

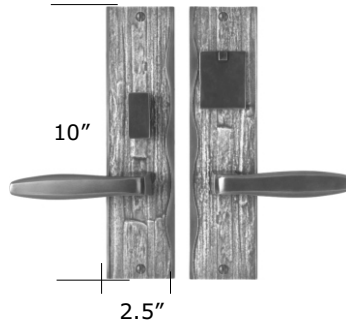

Amalfi
BE730-BL161

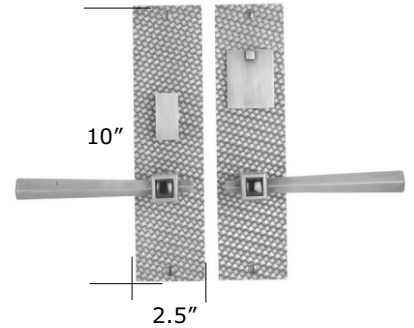

Amora Royale
w/optional semi-precious stone inlay
BE733-BLR108

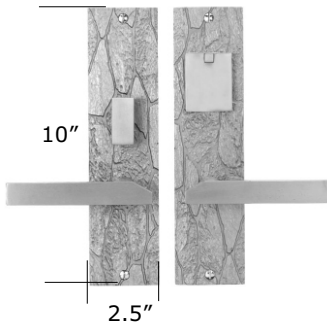

Canyon
BE736-BL162

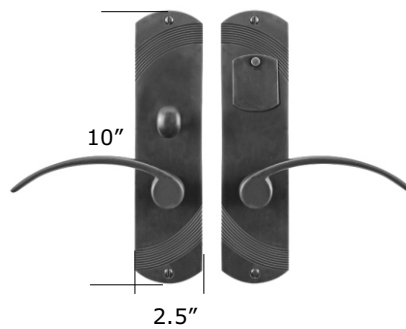

Greco
BE739-BL102



SOLID BRONZE ENTRY SETS

LEVER OR KNOB SECTIONAL DEADBOLT ENTRY SETS

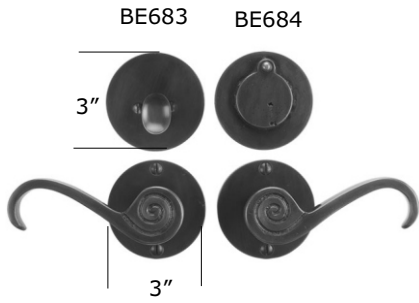

BE603 Round

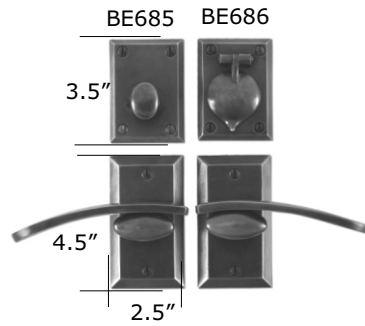

BE611 Rectangular

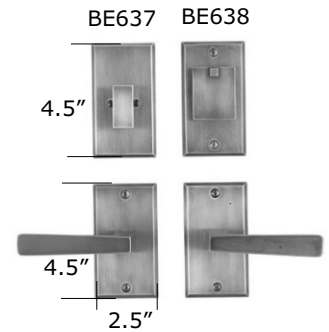

BE618 Contemporary Beveled



BE621 Notched Corner
(Also available BE689-BE690)

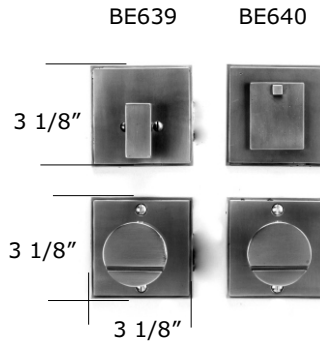

BE625 Step

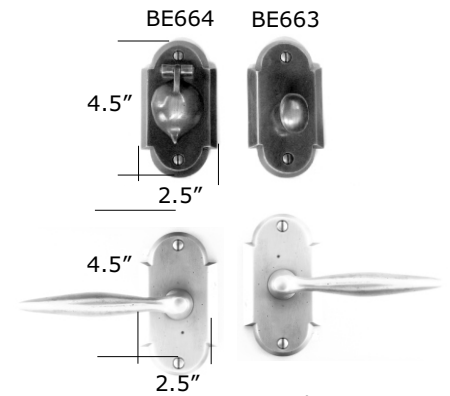

BE631 Arch

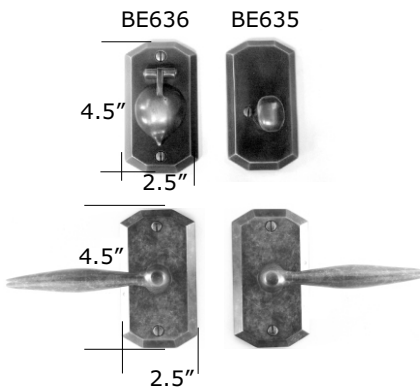

BE641 Skewed Corner

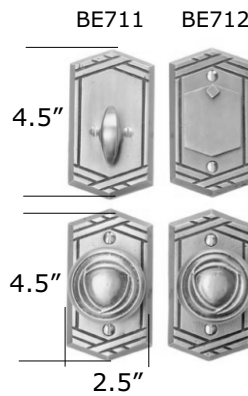

BE651 Chevron

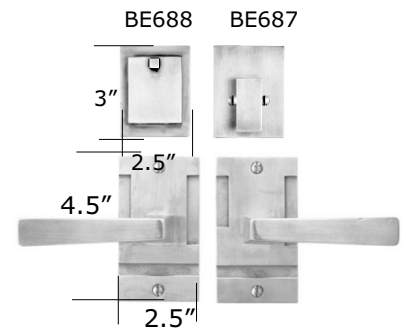

BE657 Tribeca

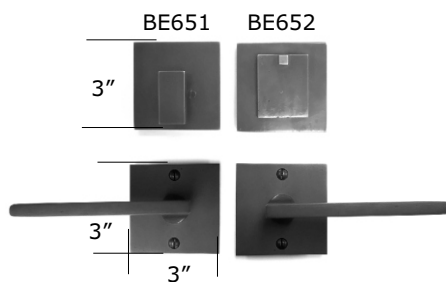

BE667 Reverse Step

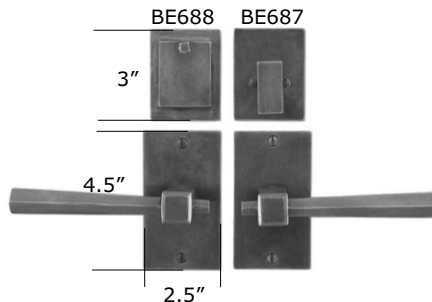

BE675 Manhattan

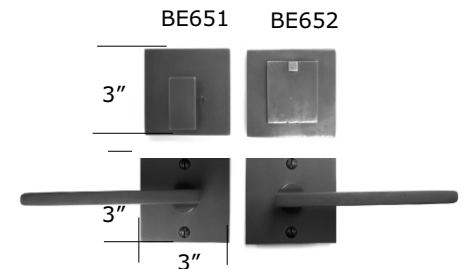

BE682 Square (Cavity)

All rights reserved. Rev 0118



SOLID BRONZE ENTRY SETS

LEVER OR KNOB SECTIONAL DEADBOLT ENTRY SETS

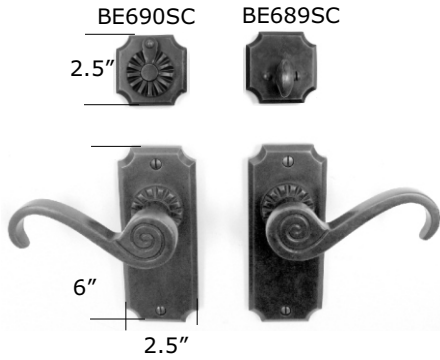

BE691S Rosette

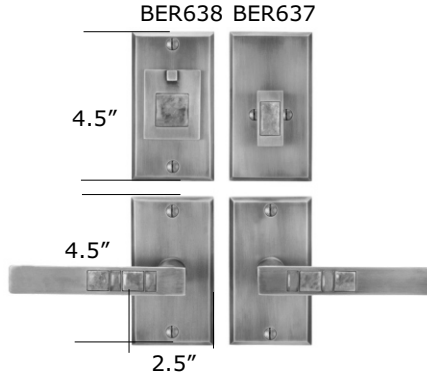

Scottsdale Royale
w/semi-precious stone inlay
BE618-BLR141

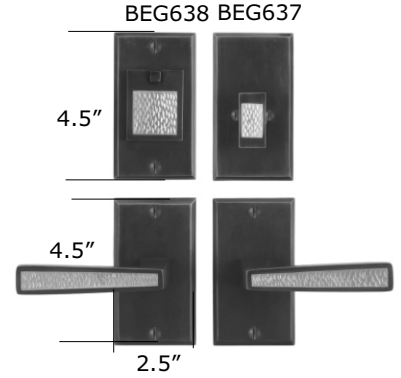

Grande Manhattan w/bronze inlay
BE618-BLG132

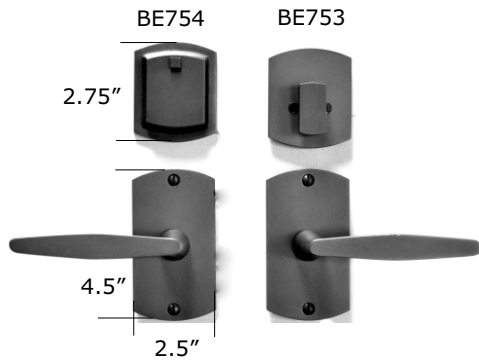

El Secreto
BE721-BL155

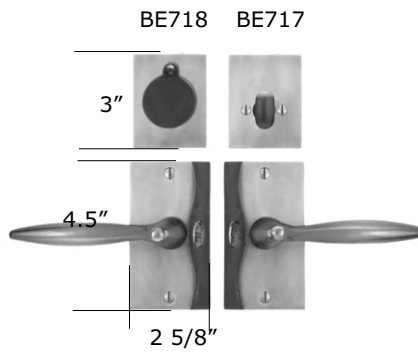

Cayman Royale
w/optional semi-precious stone inlay
BER726-BL131

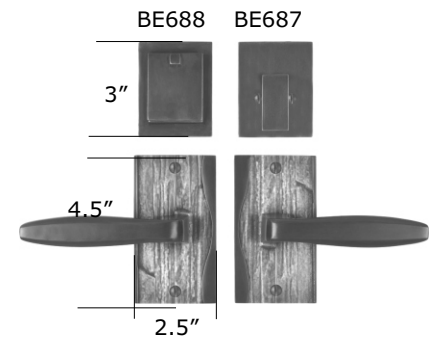

Amalfi
BE729-BL161

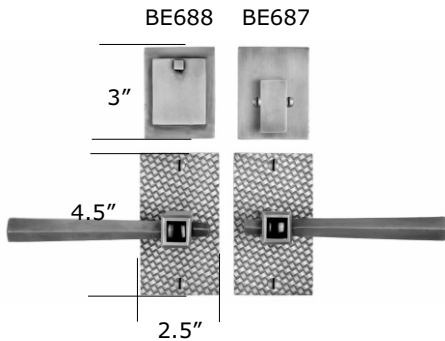

Amora Royale
w/optional semi-precious stone inlay
BE732-BLR108

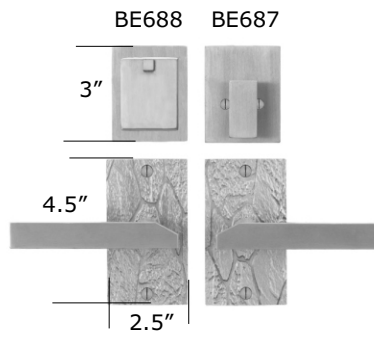

Canyon
BE735-BL162

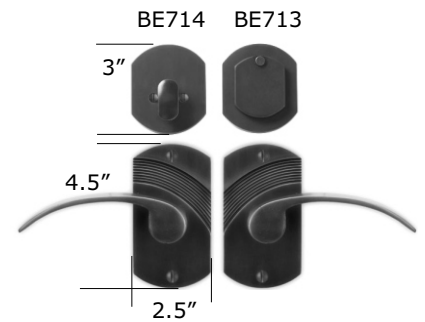

Greco
BE738-BL124



SOLID BRONZE ENTRY SETS

LEVER OR KNOB SECTIONAL DEADBOLT ENTRY SETS





SOLID BRONZE ENTRY SETS

DEADBOLTS ONLY

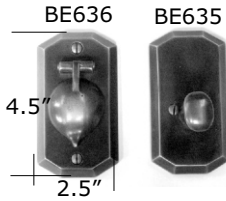

Skewed Corner

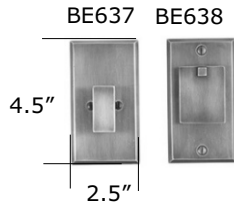

Contemporary Beveled

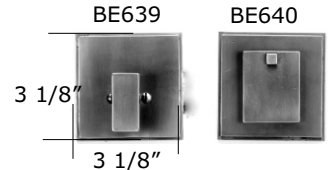

Step

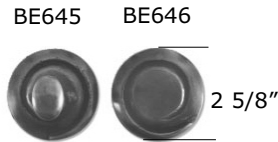

Art Nouveau

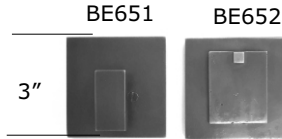

Square

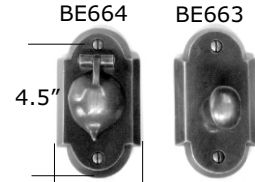

Arch

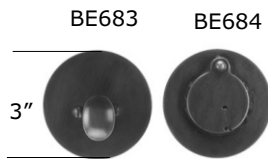

Round

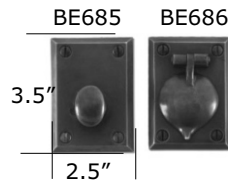

Beveled

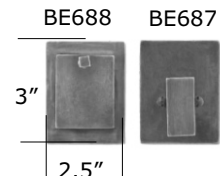

Straight Edge

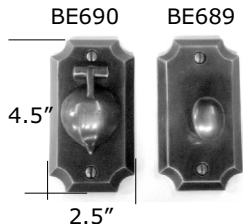

Notched Corner

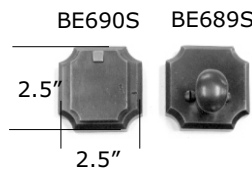

Petite Notched Corner



Rosette

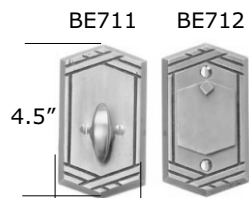

Chevron



Scottsdale Royale

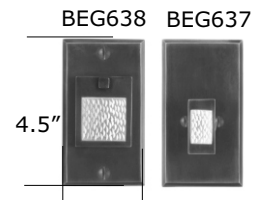

Grande Manhattan

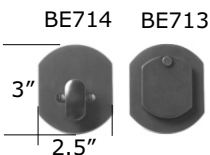

Greco

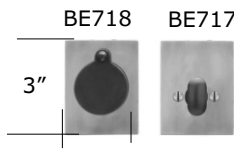

Cayman

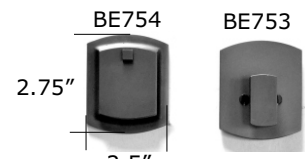

El Secreto

All rights reserved. Rev 0118



OUR UNIQUE STRIKE-BAR ENTRY SETS ARE AVAILABLE WITH DEADBOLTS. The extended bar goes on the active side of the door and acts as the latch. A mortise strike is included.

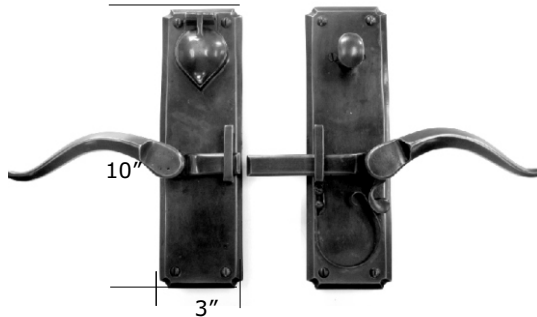

BS503 Vertical Strike-bar Latch w/ BL135 Lever (shown) or BL101 lever. Inquire about other lever options at upcharge. (Available with Mortise Deadbolt EN-MD, or Tubular Deadbolt EN-DB)

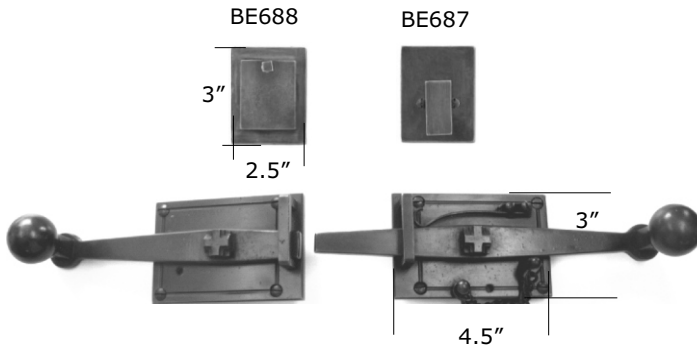

BS504 EN-DB Tweezer Strike-bar Latch with Tubular Deadbolt

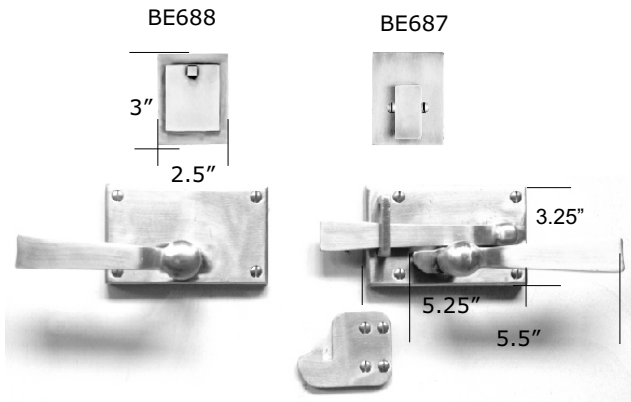

BS507 EN-DB Bermuda Gate Latch with Tubular Deadbolt



WE OFFER MULTIPOINT RETROFIT HARDWARE FOR MOST DOOR MAKES.
SEE SPEC SHEETS AND ORDER INFO FORM ON FOLLOWING PAGES FOR FUNCTIONS & REQUIRED SPECIFICATIONS.

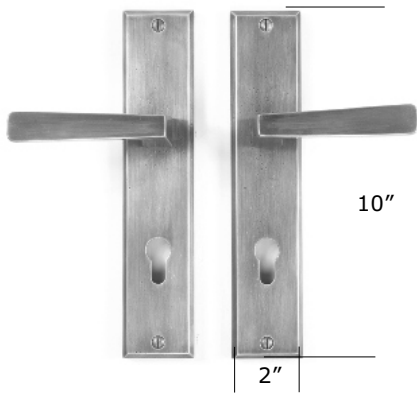

BE614N Beveled

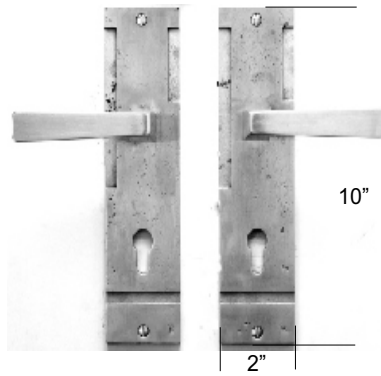

BE659 Tribeca

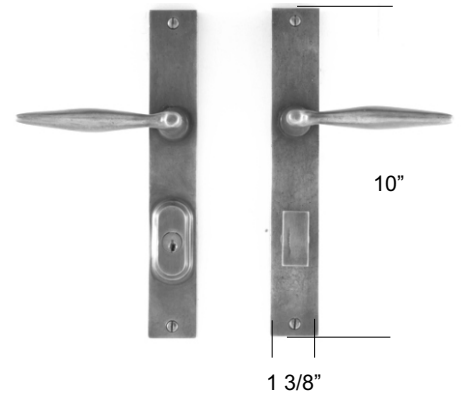

BE671 Straight Edge
No spring assist
(5" and smaller levers recommended)

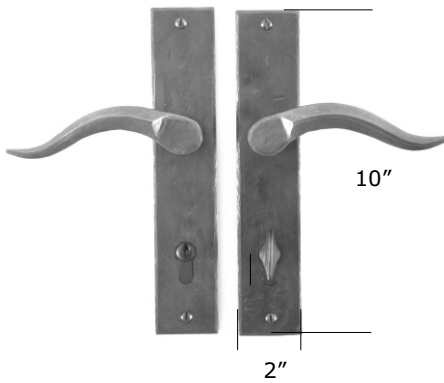

BE672 Straight Edge

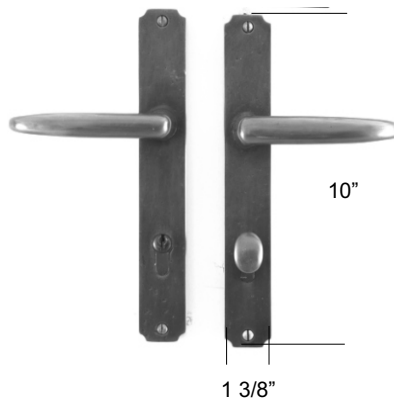

BE673 Notched Corner
No spring assist
(5" and smaller levers recommended)

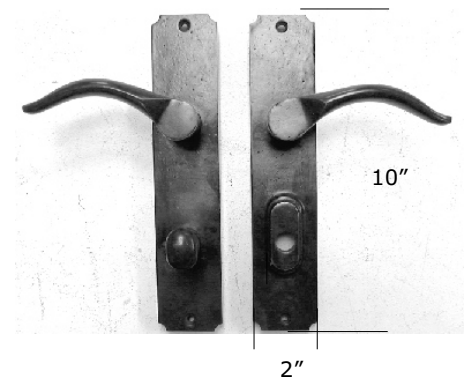

BE674 Notched Corner

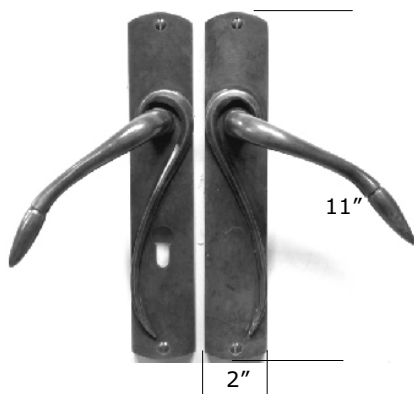

BE698 Art Nouveau

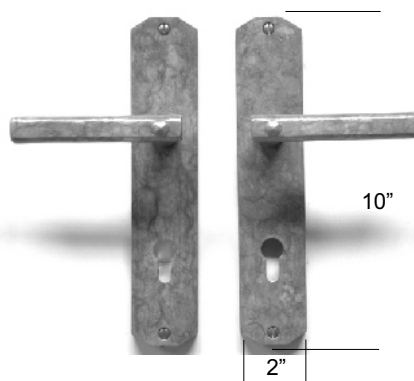

BE699 Skewed Corner

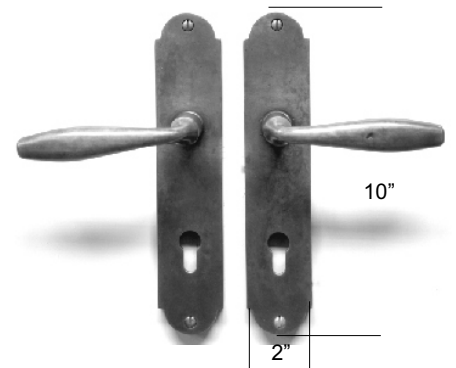

BE700 Arch

All rights reserved. Rev 0118



WE OFFER MULTIPOINT RETROFIT HARDWARE FOR MOST DOOR MAKES.
SEE SPEC SHEETS AND ORDER INFO FORM ON FOLLOWING PAGES FOR FUNCTIONS & REQUIRED SPECIFICATIONS.

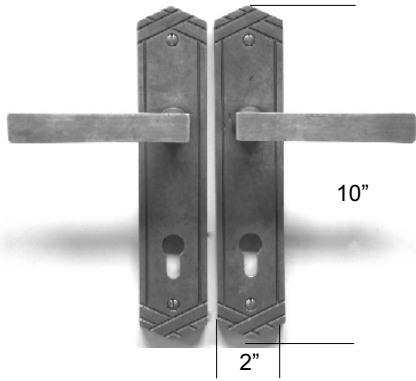

BE701 Chevron

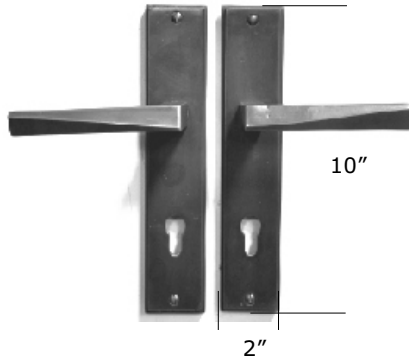

BE702 Step

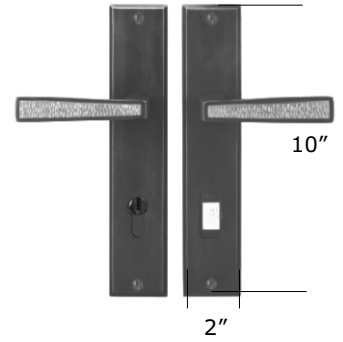

Grande Manhattan w/bronze inlay
BE614N-BLG132

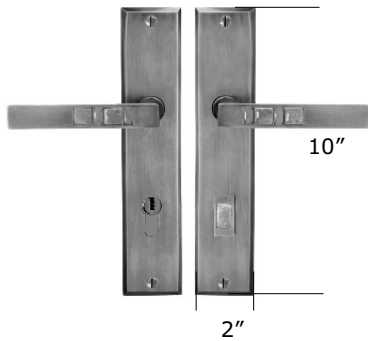

Scottsdale Royale
w/semi-precious stone inlay
BE614N-BLR141

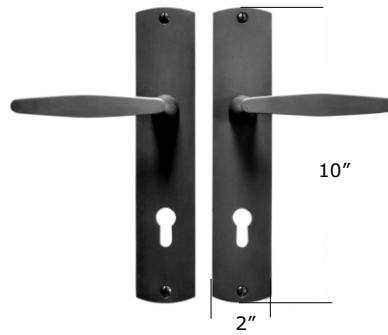

El Secreto
BE722

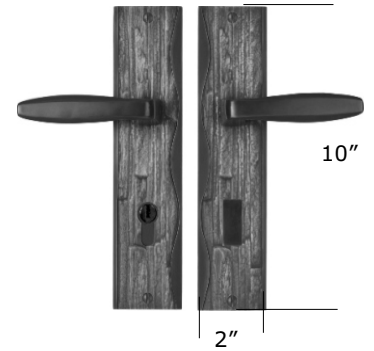

Amalfi
BE731-BL161

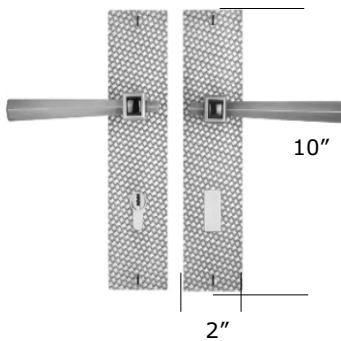

Amora Royale
w/optional semi-precious stone inlay
BE733N-BLR108

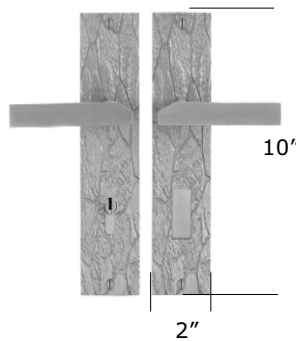

Canyon
BE736N-BL162

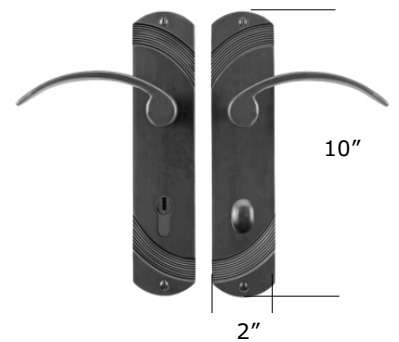

Greco
BE739N-BL102

All rights reserved. Rev 0118



WE OFFER MULTIPOINT RETROFIT HARDWARE FOR MOST DOOR MAKES.
SEE SPEC SHEETS AND ORDER INFO FORM ON FOLLOWING PAGES FOR FUNCTIONS & REQUIRED SPECIFICATIONS.

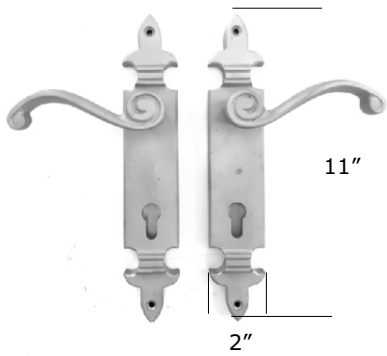

Fleur de Lis
BE743



MULTIPOINT RETROFIT HARDWARE SPECIFICATION SHEET - PG.1
LEVER HIGH, AMERICAN CYLINDER SETS

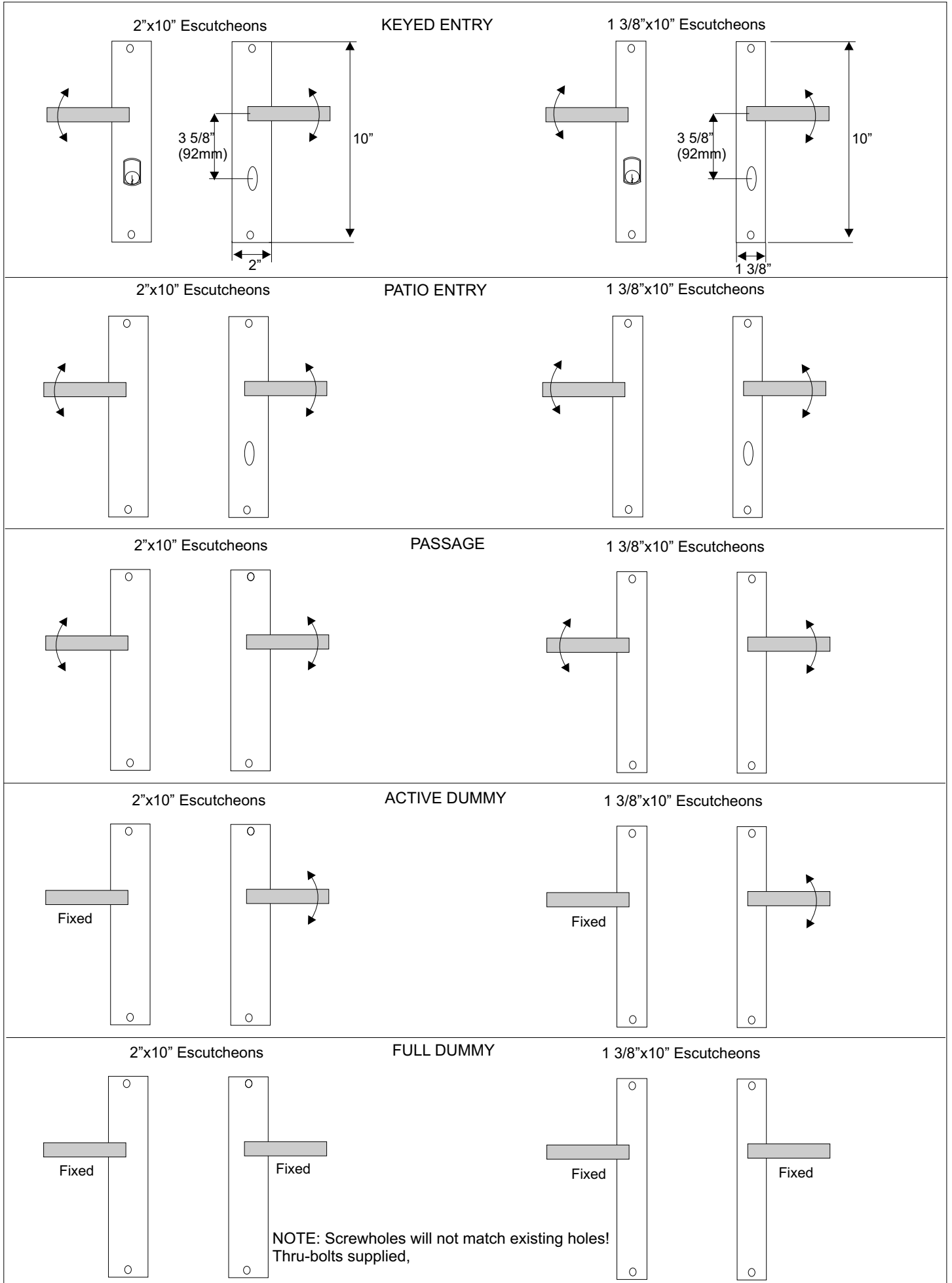



MULTIPOINT RETROFIT HARDWARE SPECIFICATION SHEET - PG.2
LEVER LOW, AMERICAN CYLINDER SETS

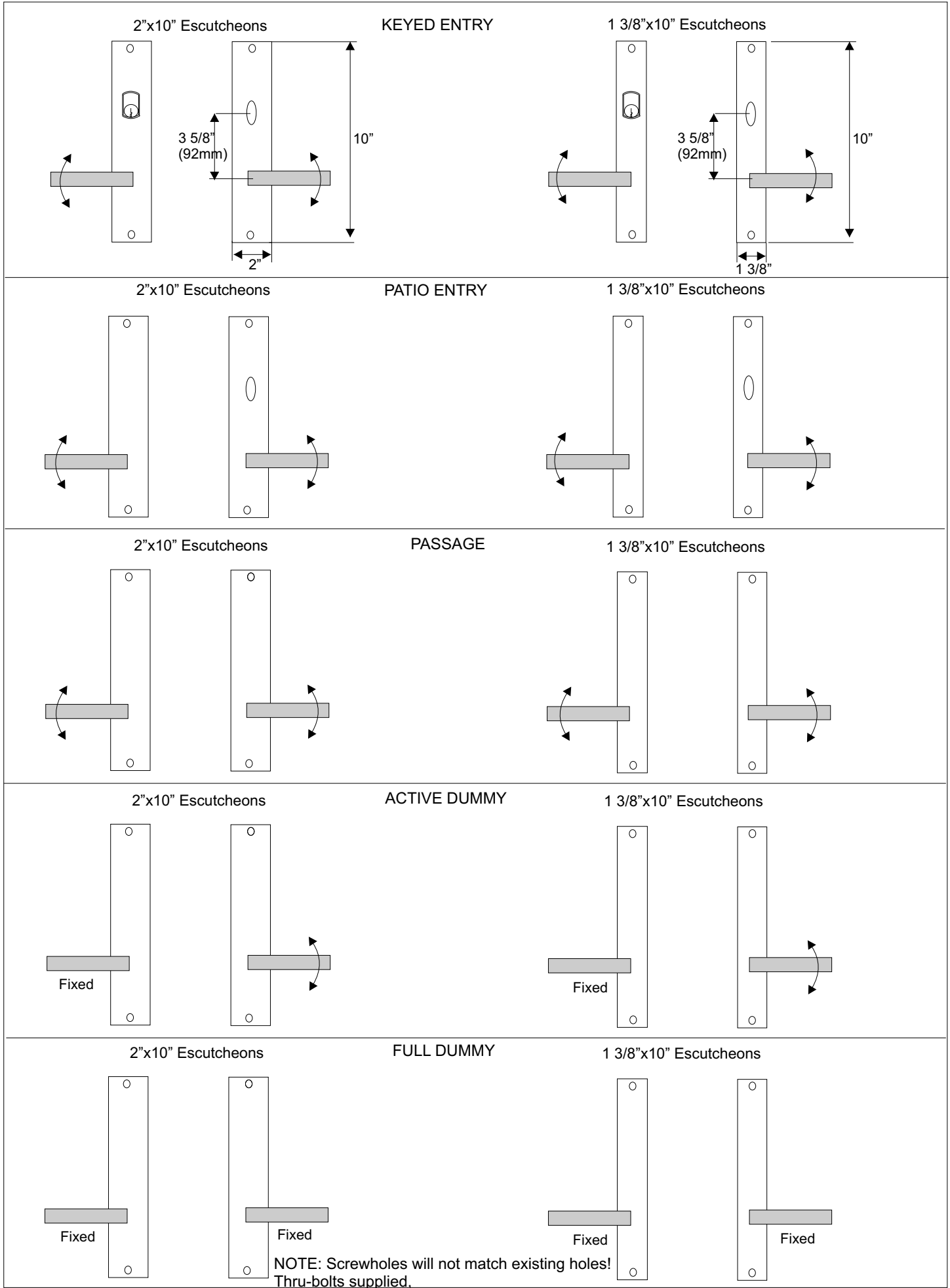

NOTE: Screwholes will not match existing holes!
Thru-bolts supplied.



MULTIPOINT RETROFIT HARDWARE SPECIFICATION SHEET - PG.3
LEVER HIGH, EUROPEAN PROFILE CYLINDER SETS

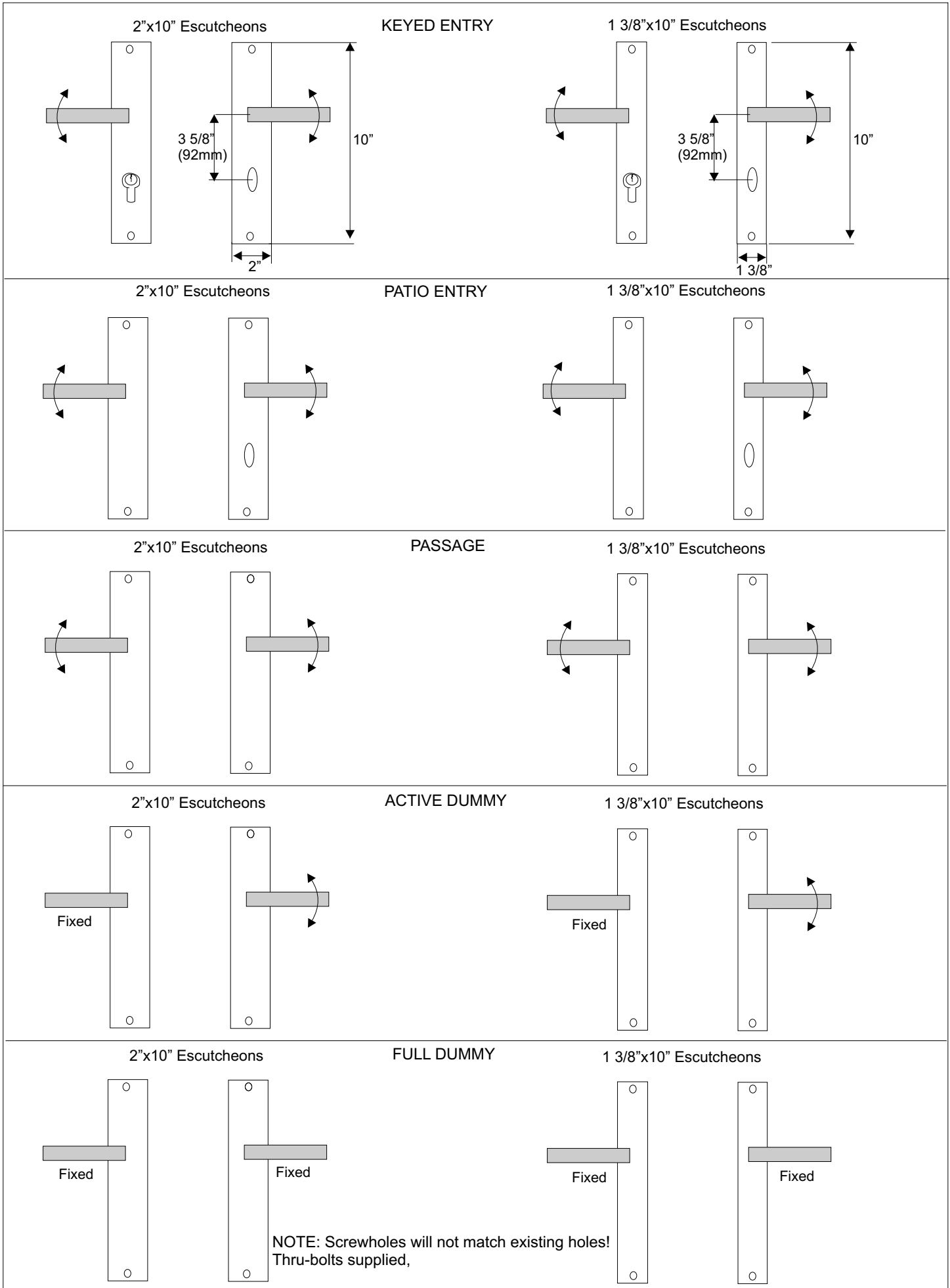

NOTE: Screwholes will not match existing holes!
Thru-bolts supplied,



HARDWARE RENAISSANCE
MULTIPOINT RETROFIT HARDWARE FORM

Please provide this with your Multipoint Retrofit order
 (REFER TO MULTIPOINT SPEC SHEETS)

DATE

DEALER

PO#

* LOCK MAKE:

* DOOR THICKNESS (1.75" std.)

* CYLINDER:

EURO PROFILE

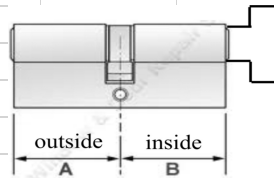

Centered in door (std.)

Offset

A:

B:

AMERICAN

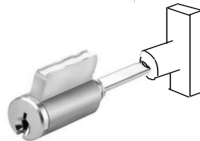

Tailpiece horizontal (std.)

Tailpiece vertical

* LEVER LOCATION:

High

Low

* CENTER TO CENTER (std. 92mm or 3 5/8"):

92mm

Other (specify)

* PASSIVE (NON-LOCKING) DOOR SETS:

FULL DUMMY (both levers fixed)

ACTIVE DUMMY (outside lever fixed, inside lever working)

PASSAGE (both levers working)

* SPINDLE (HUB) SIZE:

8mm square (std)

Other (specify)

THUMBTURNS: Contemporary styles with cuboid thumbturns. Classic styles with oval thumbturns.

HANDING guide:

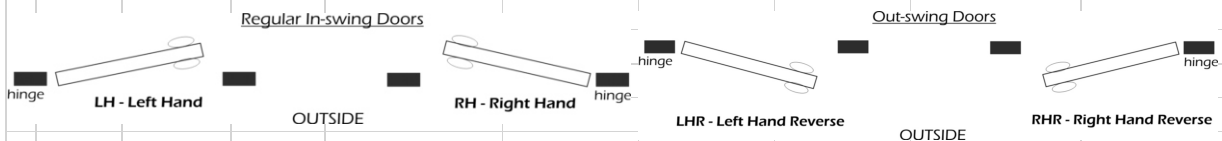

NOTE ABOUT OUR SCREW HOLE LOCATIONS: We do NOT match existing screw hole locations.

Our screw holes are made to miss existing holes. We provide thru-bolts for install.



WE OFFER SLIDING DOOR REROFIT HARDWARE FOR MOST DOOR MAKES.

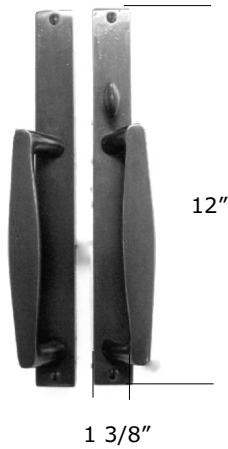

BE671L Escutcheon Patio set shown w/ BP657 Offset El Secreto Grip

ALSO BE671LB Beveled

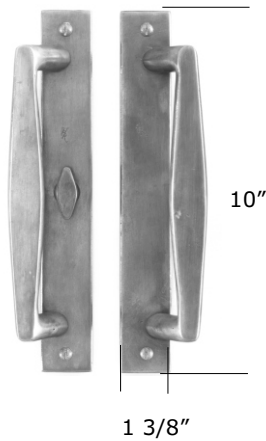

BE671 Escutcheon Patio set shown w/ BP657 Offset El Secreto 8" Grip

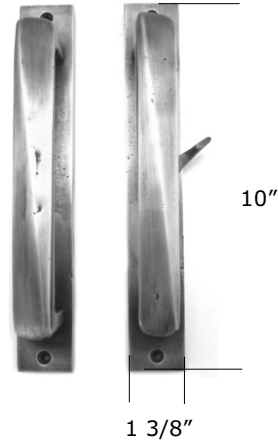

BE671 Escutcheon Patio set shown w/ BP654 Milan 8" Grip

WE NEED THE FOLLOWING TO MAKE:

1. DOOR MAKE & SET-UP (GRIP LOW OR GRIP CENTERED)
2. CHOICE OF GRIP (choice of Milan, Manhattan, El Secreto Grips or custom)
3. FUNCTION (ENTRY, PATIO, DUMMY). If ENTRY, specify American or Euro cylinder
4. HANDING (from the outside, active door sliding to the left or right)
5. TYPE OF SPINDLE (INSERT) for thumbturn

FILL OUT SLIDING DOOR INFORMATION FORM for all required specifications

NOTE: **WE DO NOT NORMALLY MATCH EXISTING SCREW HOLES. CONTACT US IF THIS IS REQUIRED.** OUR BACKPLATES ARE MADE TO MISS EXISTING HOLES. WE WILL MAKE SCREW HOLES AT THE TOP AND BOTTOM AND PROVIDE THROUGH-BOLTS FOR INSTALL.

SLIDING DOOR INFORMATION FORM

- PURCHASE ORDER # _____
- 1 Manufacturer _____
 - 2 Function _____
 - 3 Door Thickness _____
 - 4 Handing _____ (OX, XO, OR looking from the outside, the direction to which the door slides)
 - 5 Type of Spindle for turnpiece
(Circle one or send sketch if different)

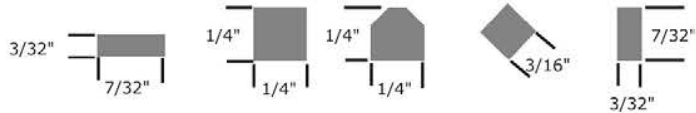

- 6 Hardware projection limitations (i.e. for screen door)? _____
- 7 Type of set-up and screw spacing (mark below OR supply drawing if different)

GRIP LOW

MAKE	DIM A	DIM B	DIM C
HOPPE	1-3/4" (1.772")	7-3/8" (7.362")	9-1/8" (9.134")
JELDWEN (A)	1-3/16" (1.818")	5-7/16" (5.427")	7-1/4" (7.245")
JELDWEN (B)	1-15/16" (1.945")	8-5/16" (8.300")	10-1/4" (10.245")
KOLBE	1-31/32" (1.969")	8-9/32" (8.277")	10-1/4" (10.246")
MARVIN	1-9/16" (1.584")	9-5/8" (9.643")	11-1/4" (11.227")
MARVIN INTEGRITY	1-15/16" (1.945")	9-31/32" (9.975")	11-15/16" (11.920")
PELLA	23/32" (.700")	7-5/16" (7.300")	8.000"
ANDERSEN	1-15/16" (1.950")	9-13/16" (9.800")	11-3/4" (11.75")
SIERRA PACIFIC	1-3/4" (1.771")	7-3/8" (7.361")	9-1/8" (9.132")
WINDSOR	1-31/32" (1.969")	9 15/16" (9.951")	11-15/16" (11.920")
OTHER			

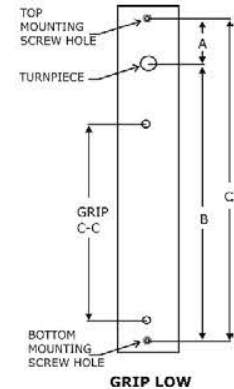

GRIP CENTERED

MAKE	DIM A	DIM B	DIM C
JELDWEN	2-23/32" (2.718")	1-1/4" (1.219")	3-15/16" (3.937")
EAGLE	1-1/4" (1.219")	2-23/32" (2.718")	3-15/16" (3.937")
MARVIN	4-15/16" (4.938")	4-15/16" (4.938")	9-7/8" (9.875")
MARVIN	1-15/16" (1.945")	1-15/16" (1.945")	3-31/32" (3.980")
OTHER			

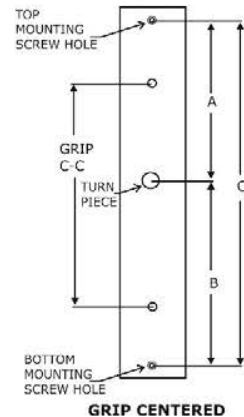

NOTE: WE DO NOT MATCH EXISTING SCREWHOLE. OUR BACKPLATES WILL MISS THEM.
 WE PROVIDE THRU-BOLTS FOR INSTALL.

SLIDING DOOR RETROFIT TRIM IS NON-RETURNABLE

Signature _____

Date _____



WE OFFER SLIDING DOOR REROFIT HARDWARE FOR MOST DOOR MAKES.



BE671 Escutcheon Entry American Cylinder set shown w/BL137-OS Offset Milan Lever

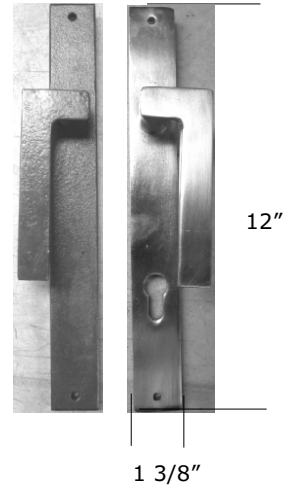

BE671L Escutcheon Patio Euro Cylinder set shown w/BL141-OS Offset Scottsdale Lever

WE NEED THE FOLLOWING TO MAKE:

1. SPECIFY LEVER (choice of Milan, Scottsdale, or custom)
SPECIFY LEVERS FIXED OR WORKING.
2. SPECIFY FUNCTION (ENTRY OR PATIO)
3. SPECIFY TYPE OF CYLINDER (American or Euro Profile)
4. SPECIFY HANDING (from exterior side, active door sliding left or right)
5. Spindle size (for working levers)
6. SEND US LOCK TEMPLATE OR SKETCH SHOWING:
 - a) center-to-center between existing screw holes
 - b) center-to-center between lever and lock hub
 - c) LOCK height

NOTE: **WE DO NOT MATCH EXISTING SCREW HOLES.** OUR BACKPLATES ARE MADE TO MISS EXISTING HOLES. WE WILL MAKE SCREW HOLES AT THE TOP AND BOTTOM AND PROVIDE THROUGH-BOLTS FOR INSTALL.



LIFT & SLIDE SETS TYPICALLY CONSIST A FLUSH PULL OUTSIDE, & LONG LEVER INSIDE.
STANDARD LEVER HUB IS 10MM SQUARE.

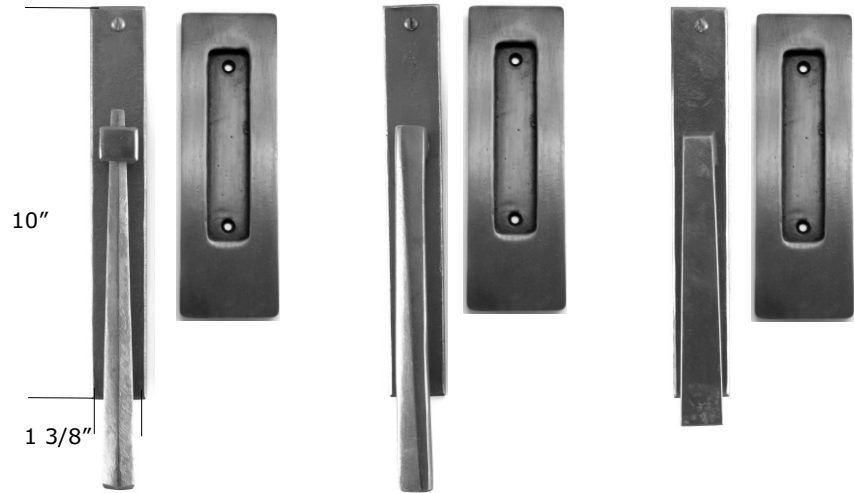

BE671 Escutcheon set shown w/ BL108L East-West 9" Lever & BP712 Flush Pull

BE671 Escutcheon set shown w/ BL137L Milan 9" Lever & BP712 Flush Pull

BE671 Escutcheon set shown w/ BL132L Manhattan 7" Lever & BP712 Flush Pull

INQUIRE ABOUT OTHER LEVER & ESCUTCHEON OPTIONS.



CONTENTS

This section contains all types of interior door hardware, such as passage privacy, dummy sets, pocket door hardware, and door pulls.

Levers & Knobs	Page L-1 / L-2
Escutcheons (Passage, Privacy, Dummy)	Page 7-1 / 7-5
Petite Series Passage, Privacy, Dummy sets	Page 7-6
Privacy Bolts	Page 7-7
Strike-bar Latch Passage, Privacy, Dummy sets	Page 7-8
Pocket Door Hardware	Page 7-9
Screen Door Hardware	Page 7-10
Door/ Appliance Pulls	Page 7-11 / 7-14
Push Plates	Page 7-14



SOLID BRONZE LEVERS & KNOBS



BL101 Verona

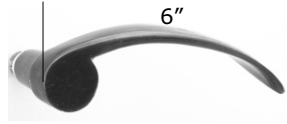

BL102 Soho



BL103 Casa California

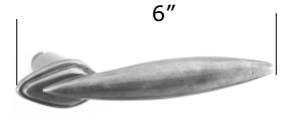

BL105 Art Deco



BL107 Neha

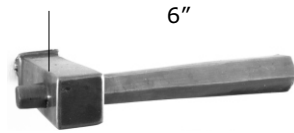

BL108 East-West

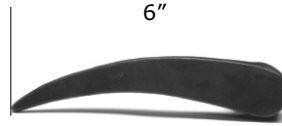

BL109 Fleetwood

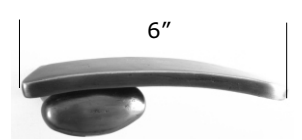

BL110 Eagle Eye



BL112 Dophin



BL131 Accent

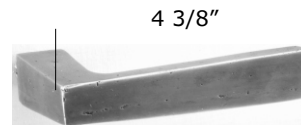

BL132 Manhattan



BL135 Verona II

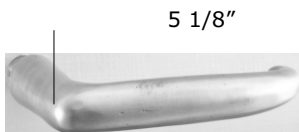

BL136 Capri



BL137 Milan



BL138 Del Mar



BL139 Chelsea

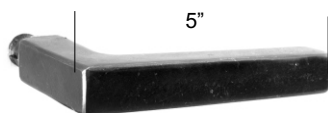

BL140 Bay

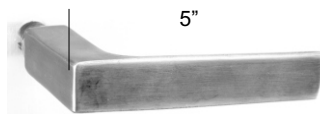

BL141 Scottsdale



BL142 Taos

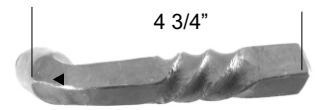

BL143 Toscana

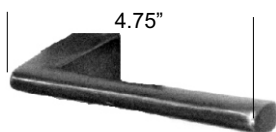

BL145 Salon



BL146 Fleur de Lis



BL147 Taylor Lever

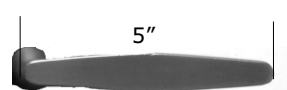

BL155 El Secreto Lever
All rights reserved. Rev 1014



SOLID BRONZE LEVERS & KNOBS



BL159 Alcott Lever

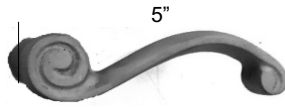

BL164 Dauphine Lever

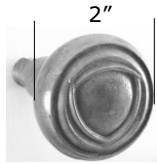

BK201 Art Deco Round

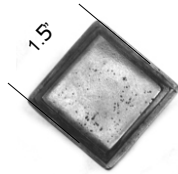

BK202 Art Deco Square



BLK203 Casa California

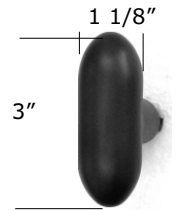

BK204 East-West



BK205 Sunrise

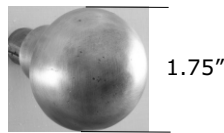

BK206 Mushroom

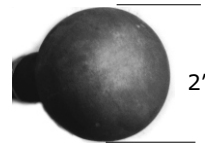

BK207 Ball Knob

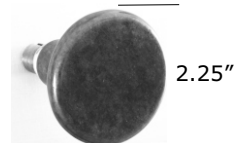

BK208 Martini

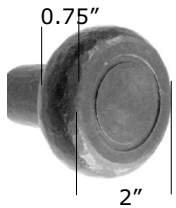

BK209 Hampton



BK210 Eagle Eye

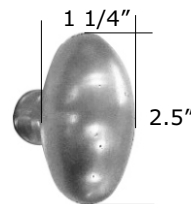

BK212 Bermuda

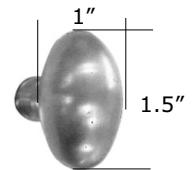

BK212S Petite Bermuda

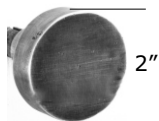

BK214 Eclipse



SOLID BRONZE INTERIOR DOOR HARDWARE

PASSAGE, PRIVACY, & DUMMY ESCUTCHEONS

PRICE INCLUDES ANY LEVER, KNOB OR RING PULL

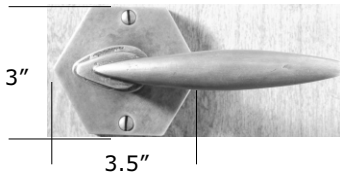

BE601 Hexagonal

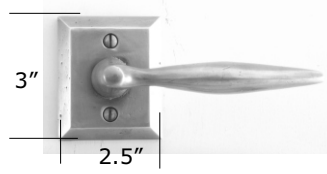

BE602 Petite Beveled*

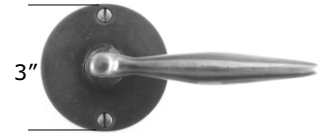

BE603 Round

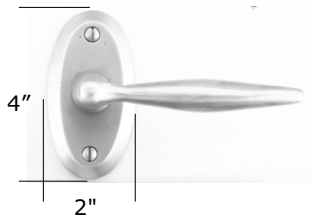

BE605 Oval*

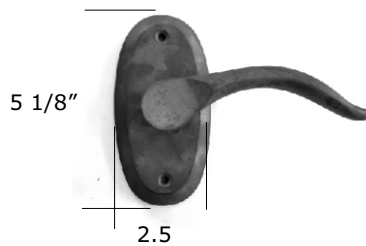

BE604 Oval

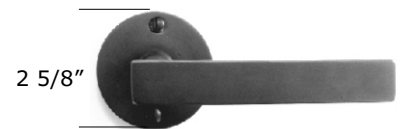

BE606L Round*

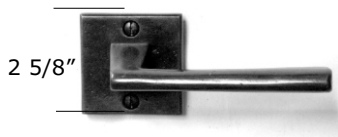

BE607L Square*

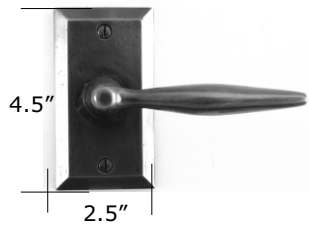

BE611 Traditional Beveled

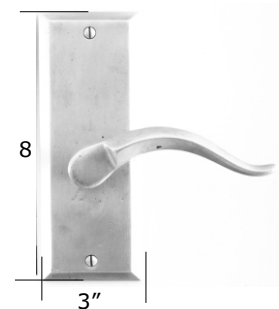

BE612 Traditional Beveled

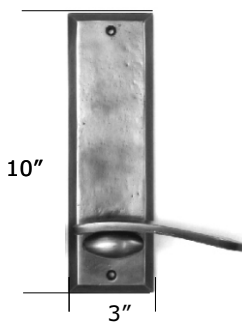

BE613 Traditional Beveled

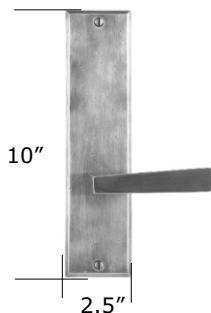

BE614 Beveled

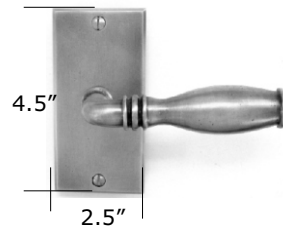

BE618 Beveled

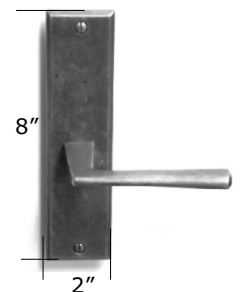

BE619 Beveled*

*WILL NOT WORK WITH PRE-BORED DOORS!

All rights reserved. Rev 0118



SOLID BRONZE INTERIOR DOOR HARDWARE

PASSAGE, PRIVACY, & DUMMY ESCUTCHEONS

PRICE INCLUDES ANY LEVER, KNOB OR RING PULL

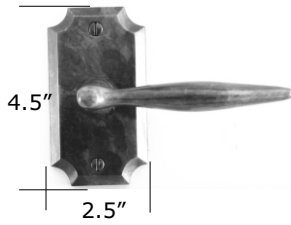

BE621 Notched Corner

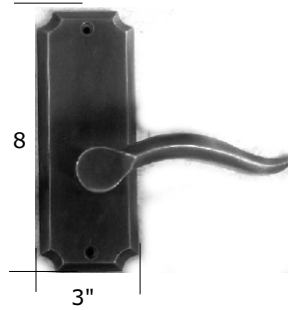

BE622 Notched Corner

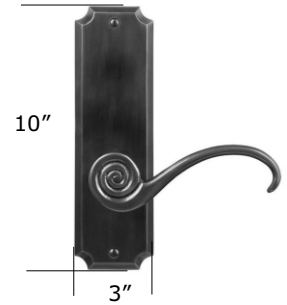

BE623 Notched Corner

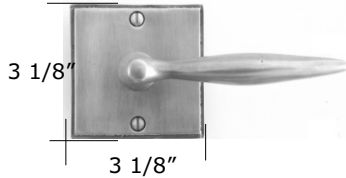

BE625 Step

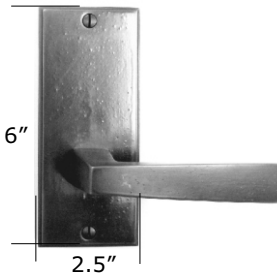

BE626 Step

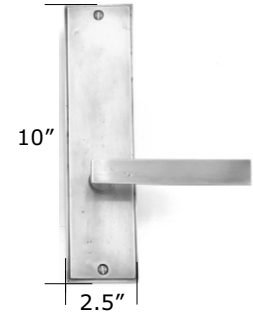

BE627 Step

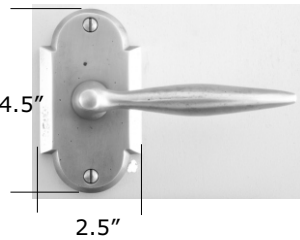

BE631 Arch

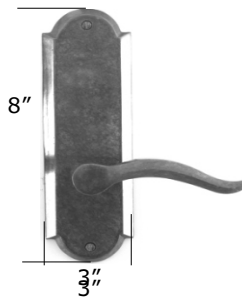

BE632 Arch

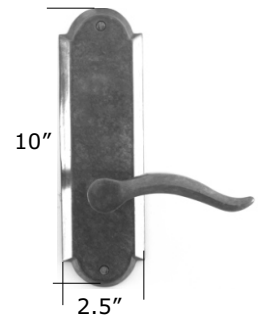

BE633 Arch

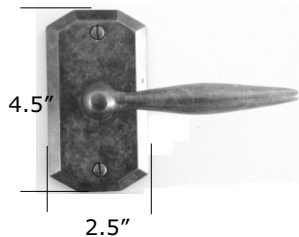

BE641 Skewed Corner

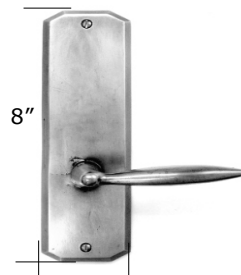

BE642 Skewed Corner

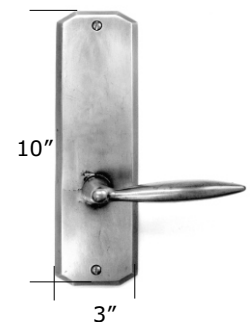

BE643 Skewed Corner

*WILL NOT WORK WITH PRE-BORED DOORS!

All rights reserved. Rev 1014



SOLID BRONZE INTERIOR DOOR HARDWARE

PASSAGE, PRIVACY, & DUMMY ESCUTCHEONS

PRICE INCLUDES ANY LEVER, KNOB OR RING PULL

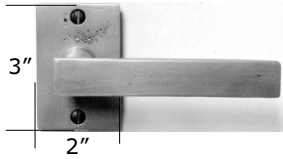

BE644 Manhattan*

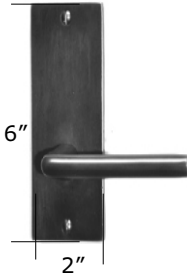

BE647 Manhattan*

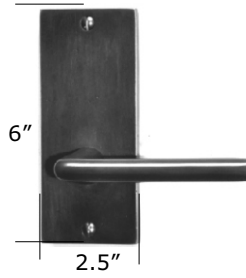

BE647W Manhattan

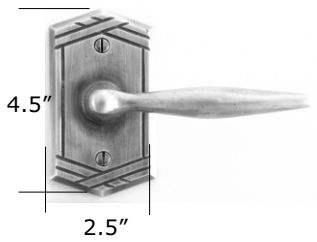

BE651 Chevron

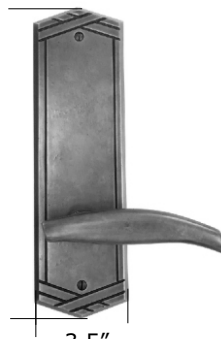

BE653 Chevron

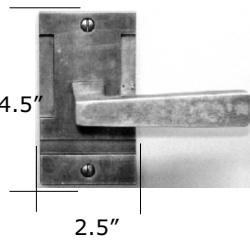

BE657 Tribeca

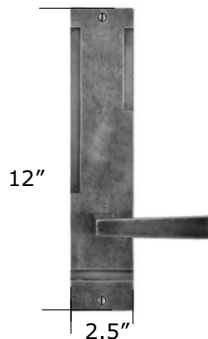

BE658 Tribeca

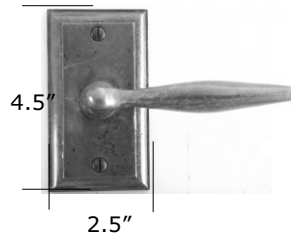

BE662 Neapolitan

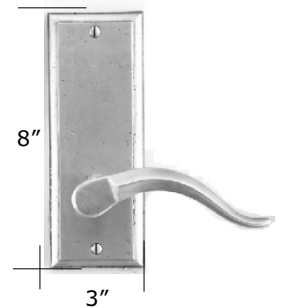

BE661 Neapolitan

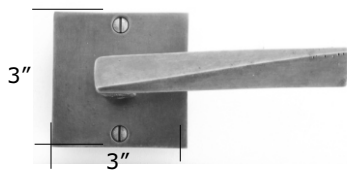

BE667 East-West (Hidden Step)

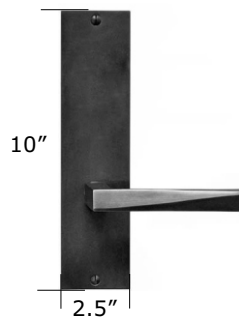

BE669 East-West (Hidden Step)

*WILL NOT WORK WITH PRE-BORED DOORS!

All rights reserved. Rev 0118



SOLID BRONZE INTERIOR DOOR HARDWARE

PASSAGE, PRIVACY, & DUMMY ESCUTCHEONS

PRICE INCLUDES ANY LEVER, KNOB OR RING PULL

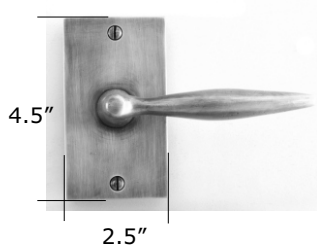

BE675 Manhattan

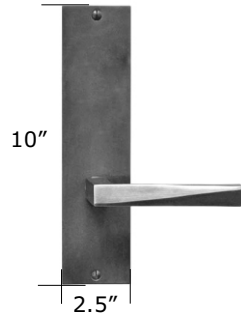

BE676 Manhattan

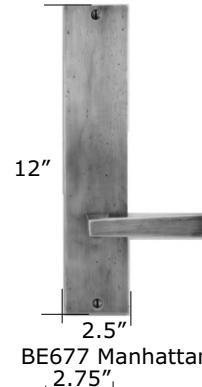

BE677 Manhattan

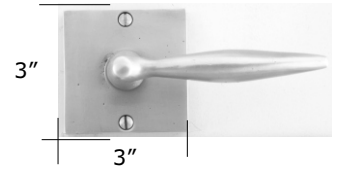

BE682 Square (w/cavity)

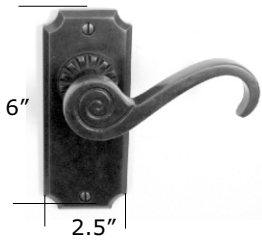

BE691S Rosette

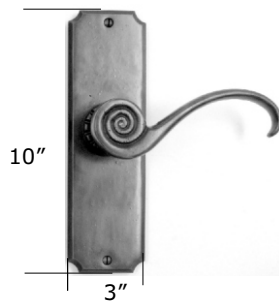

BE691L Rosette



BE692 Art Deco*

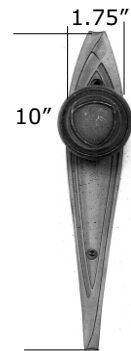

BE693 Art Deco*

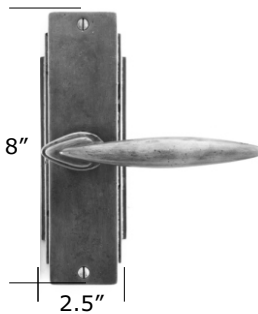

BE694 Art Deco Ridged



BE724 Chateau

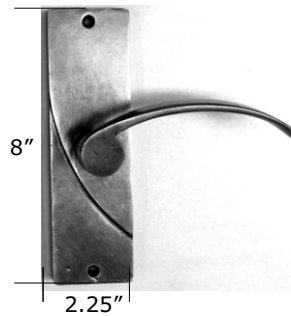

BE695 Art Nouveau II*



BL104 Art Nouveau

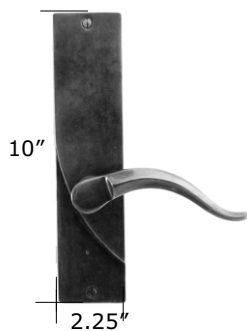

BE696 Art Nouveau II*

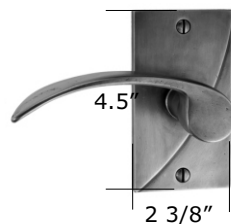

BE697 Art Nouveau II*



BE742 Fleur de Lis

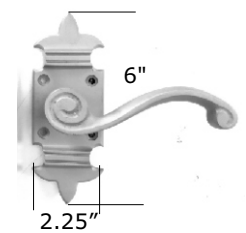

BE744 Fleur de Lis

*WILL NOT WORK WITH PRE-BORED DOORS!

All rights reserved. Rev 0118



SOLID BRONZE INTERIOR DOOR HARDWARE

PASSAGE, PRIVACY, & DUMMY ESCUTCHEONS

THESE ARE OUR NEW CURATED SERIES & ARE AVAILABLE AS SHOWN ONLY

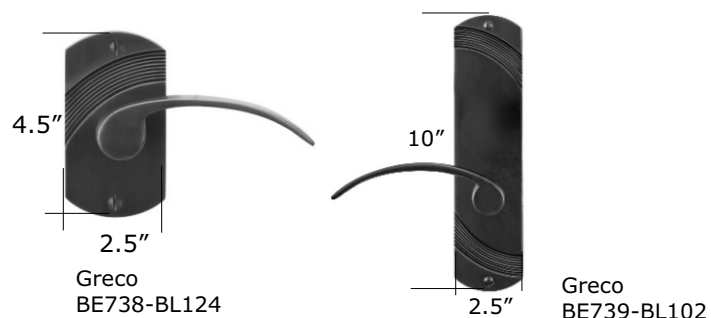
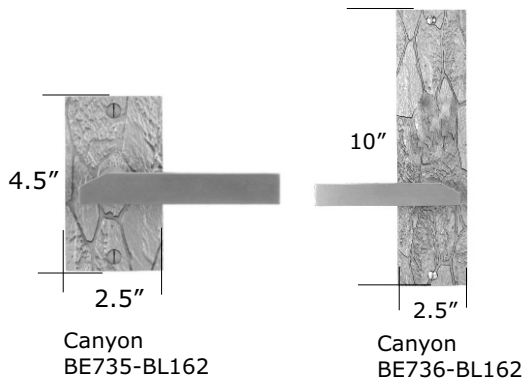
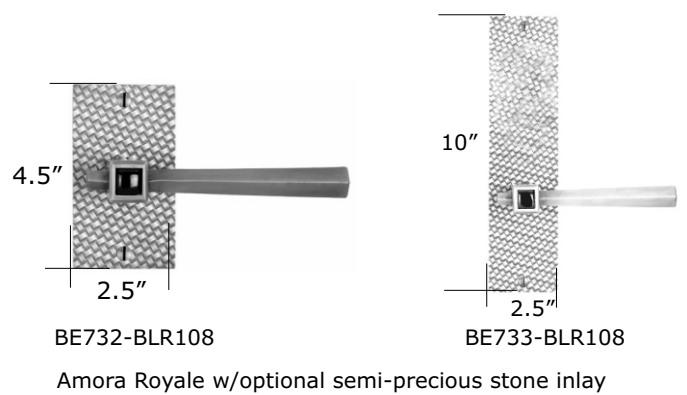
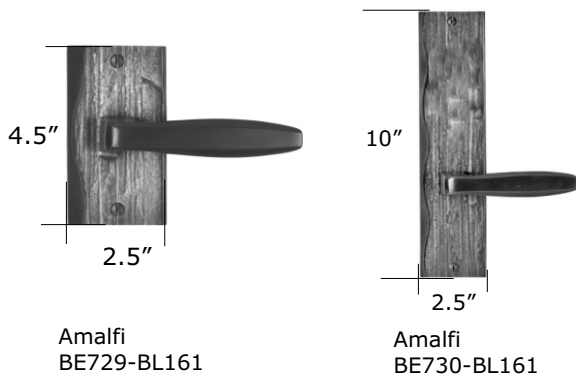
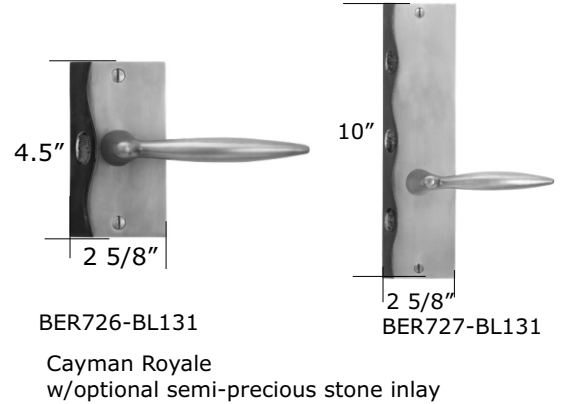
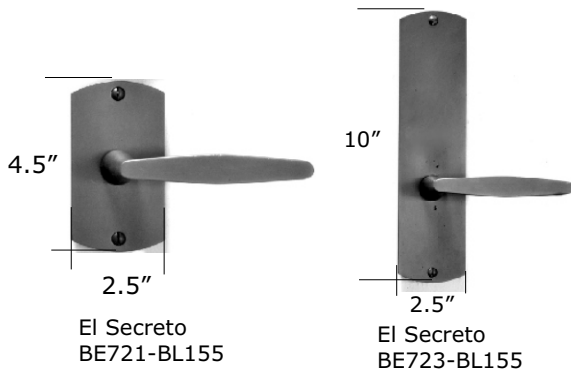
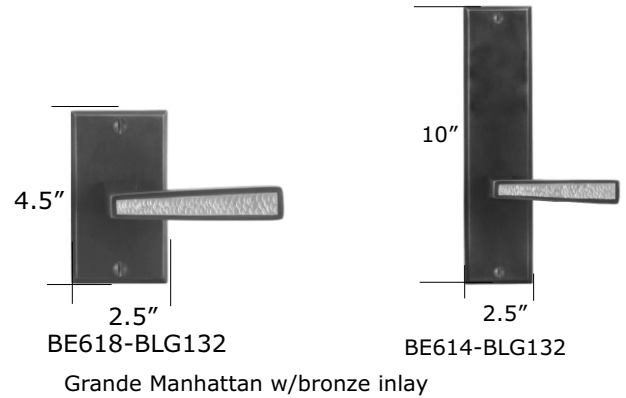
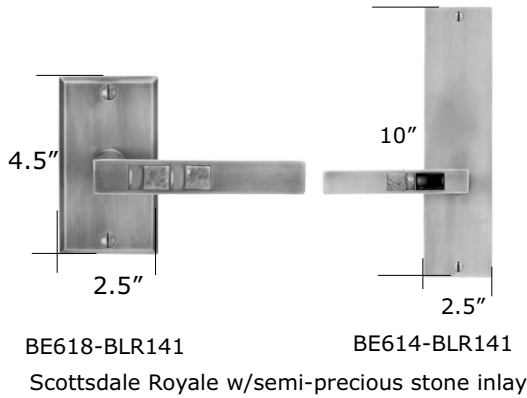

All rights reserved. Rev 0118



SOLID BRONZE INTERIOR DOOR HARDWARE

PETITE SERIES LEVERS & ESCUTCHEONS

THE FOLLOWING LEVER/ KNOB & ESCUTCHEON SETS ARE AVAILABLE AT PETITE SERIES PRICING.

Tubular Passage, Privacy, & Dummy sets only. Available in all patinas.



BL121 Petite Verona

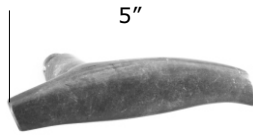

BL122 Petite Neha



BL123 Petite Wave



BL124 Petite Soho



BL125 Petite Casa California

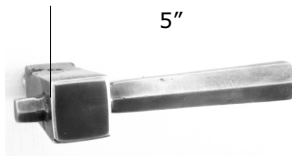

BL126 Petite East-West



BL127 Petite Dolphin

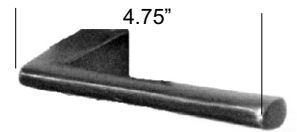

BL145 Salon

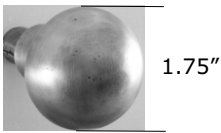

BK206 Mushroom

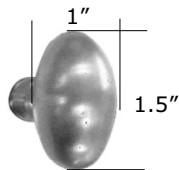

BK212S Petite Bermuda



BE603 Round



BE606L Round*

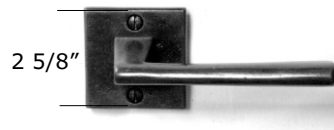

BE607L Square*

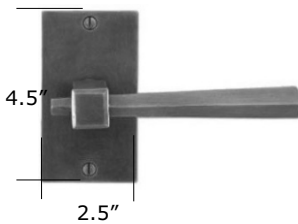

BE675 Manhattan

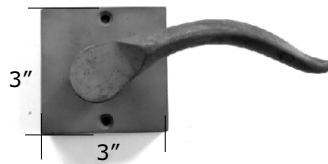

BE682 Square

*WILL NOT WORK WITH PRE-BORED DOORS!

All rights reserved. Rev 1014



PRIVACY MORTISE BOLTS (PMB) CAN BE ORDERED ON THEIR OWN OR ADDED TO ANY PASSAGE SET

EMERGENCY EGRESS COVER (OUTSIDE):



0.75"

PMB-CO2

AVAILABLE THUMBTURNS (INSIDE):

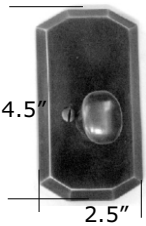

BE635



BE637

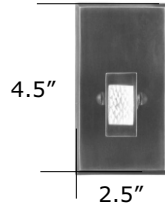

BEG637



BER637

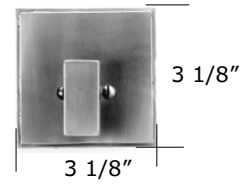

BE639



BE645

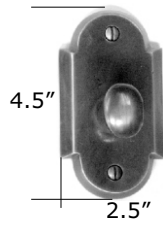

BE663



BE683

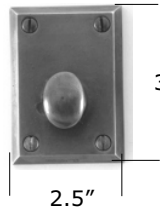

BE685

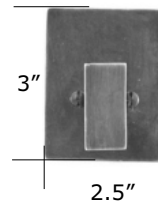

BE687

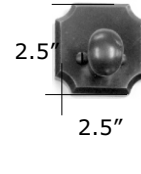

BE689S

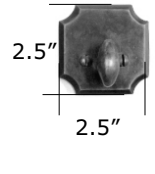

BE689SC

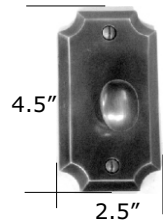

BE689

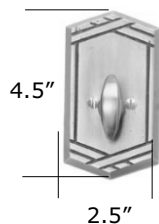

BE711

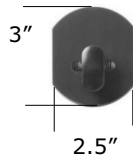

BE713

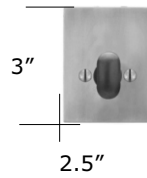

BE717

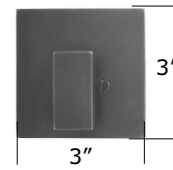

BE751

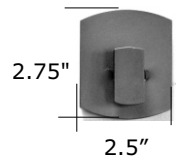

BE753



SOLID BRONZE INTERIOR DOOR HARDWARE

STRIKE-BAR LATCH PASSAGE/ PRIVACY SETS

OUR UNIQUE STRIKE-BAR SETS ARE AVAILABLE IN PASSAGE, PRIVACY & DUMMY FUNCTIONS.

The Extended bar goes on the active side of the door and acts as the latch. A partial mortise strike is included.

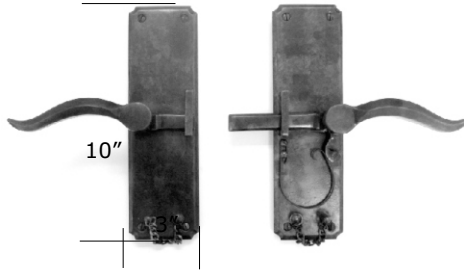

BS503 Vertical Strike-bar Latch (Passage shown with optional dummy chains). Available with BL101 Lever (shown) or BL135 Lever.

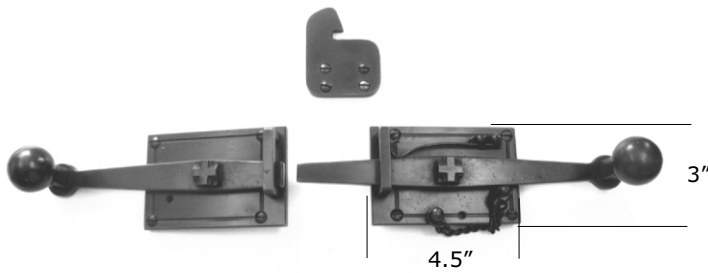

BS504 Tweezer Latch (Privacy shown with locking chain. Emergency egress included. NO LEVER OPTIONS)

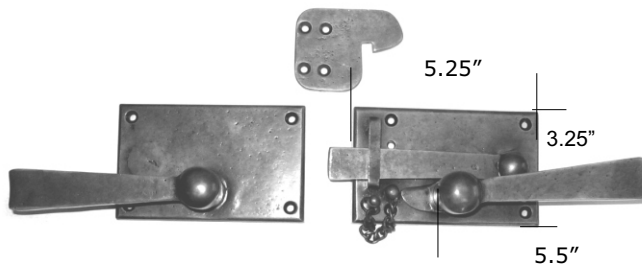

BS507 Bermuda Gate Latch (Privacy shown with locking chain. Emergency egress included). NO LEVER OPTIONS

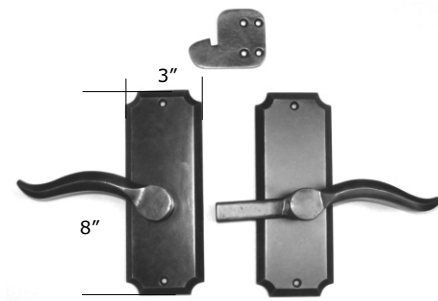

BL111-BE622 Verona Strike-bar Latch (Passage shown). NO LEVER OPTIONS

All rights reserved. Rev0118



PASSAGE FLUSH PULLS

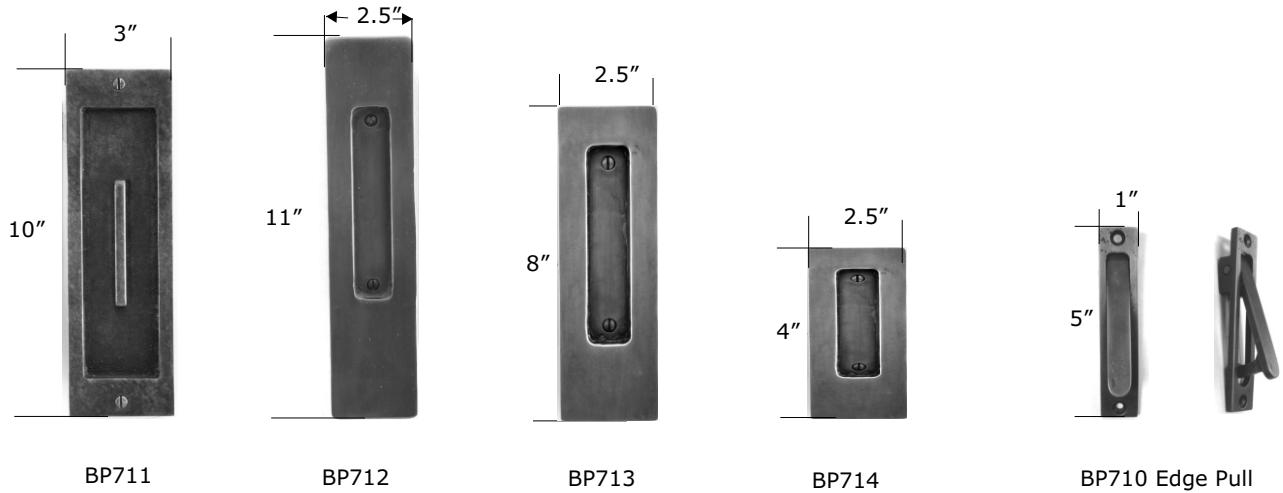

BP711 & BP713 POCKET MORTISE SETS available in Privacy or Keyed
(Minimum 1.75" door thickness)

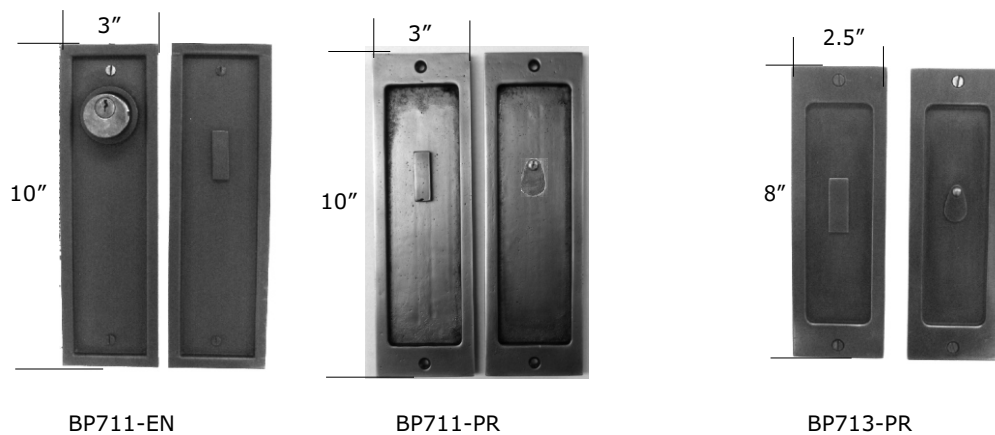



Our Screen door hardware is available with 2" wide Escutcheons in Passage, Privacy, & Dummy sets.

Available in 1.5", 1.75" & 2" backsets.

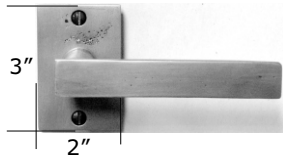

BE644 Manhattan*

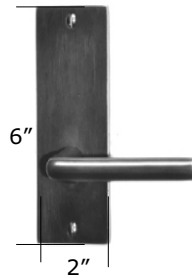

BE647 Manhattan*

* WILL NOT WORK WITH PRE-BORED DOORS



AVAILABLE FOR FRONT-MOUNT OR BACK-TO-BACK MOUNTING (specify door thickness)

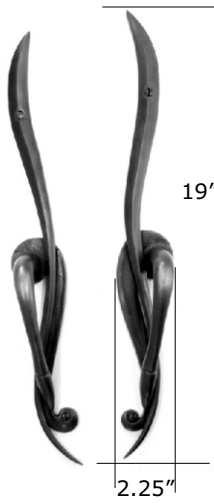

LH RH
BP106 Art Nouveau

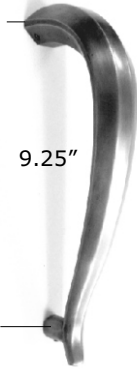

BP443 Verona
(3.25" projection)



BP705 East-West
(3.5" projection)

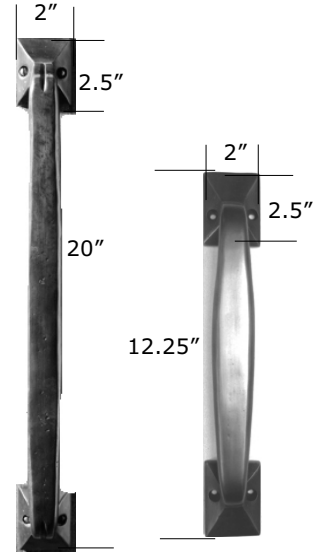

BP707L BP707
El Secreto Door Pulls
(2.5" projection)

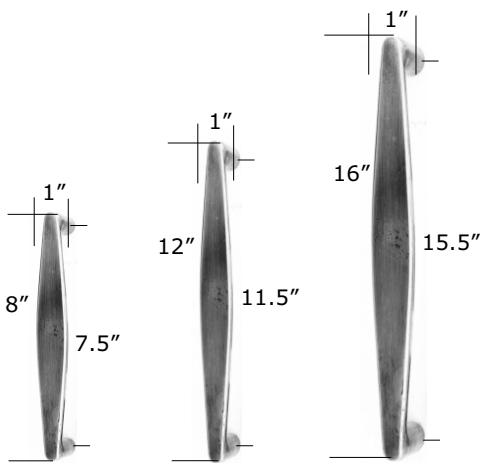

BP707S-AP-8 BP707S-AP-12 BP707S-AP-16

El Secreto Appliance Pulls
(1.5"- 1.75" projection)

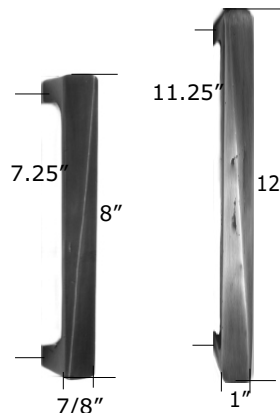

BP654 BP725-12

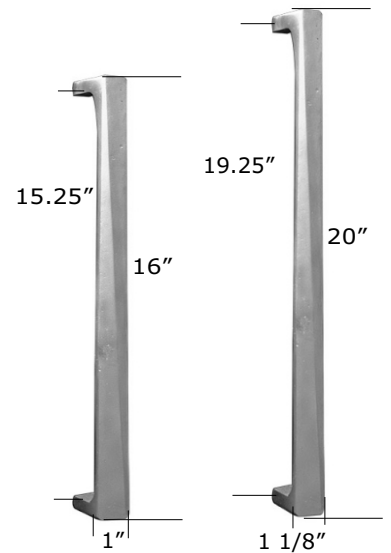

BP725-16 BP725-20

Milan Pulls
(2" projection)

All rights reserved. Rev 0118



AVAILABLE FOR FRONT-MOUNT OR BACK-TO-BACK MOUNTING (specify door thickness)

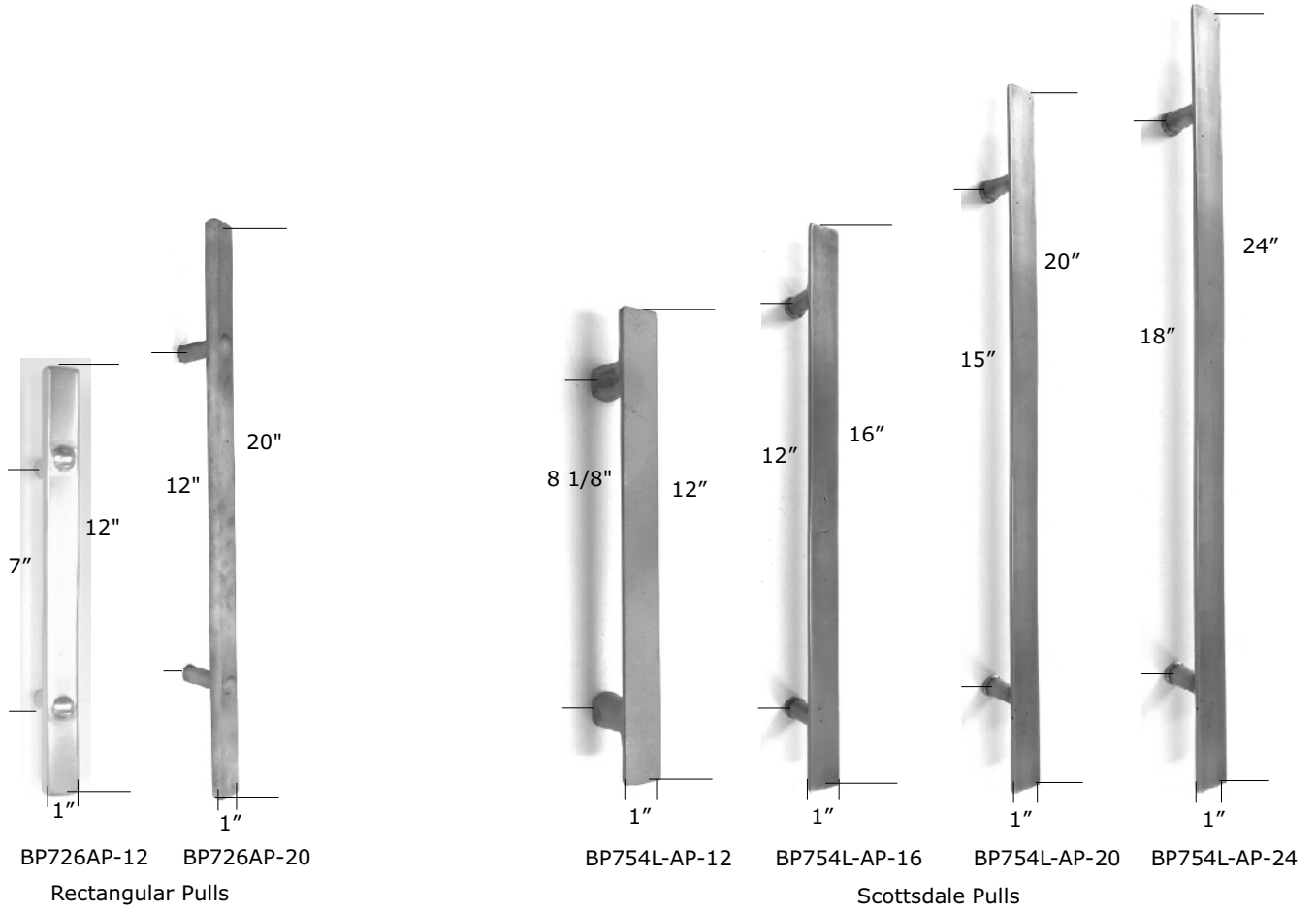

BP726AP-12 BP726AP-20
Rectangular Pulls

BP754L-AP-12 BP754L-AP-16 BP754L-AP-20 BP754L-AP-24
Scottsdale Pulls

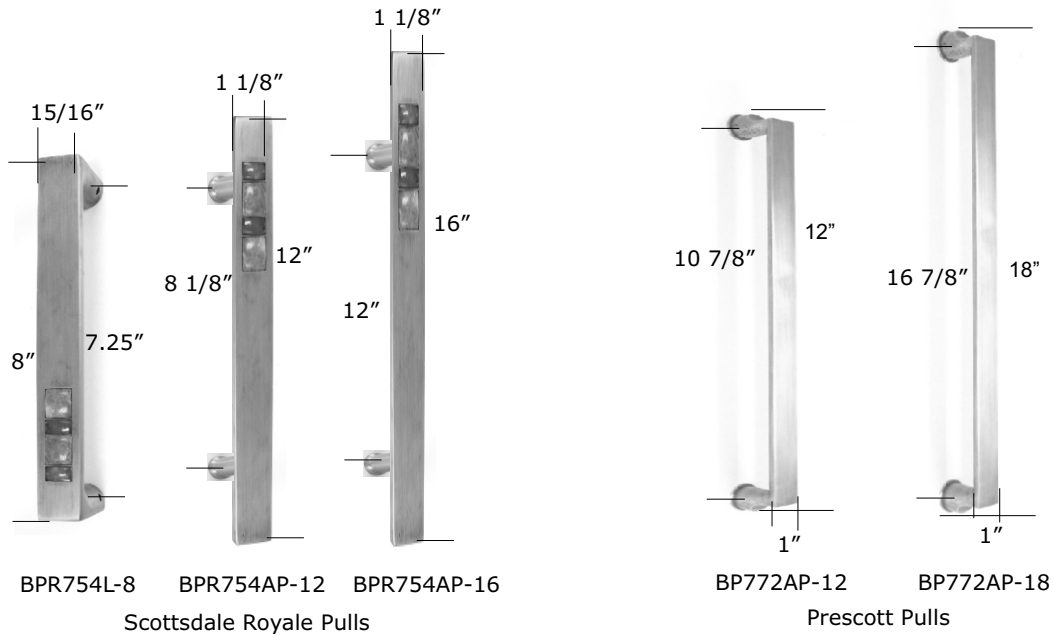

BPR754L-8 BPR754AP-12 BPR754AP-16
Scottsdale Royale Pulls

BP772AP-12 BP772AP-18
Prescott Pulls

(2" projection on all of these pulls)

All rights reserved. Rev 0118



AVAILABLE FOR FRONT-MOUNT OR BACK-TO-BACK MOUNTING (specify door thickness)

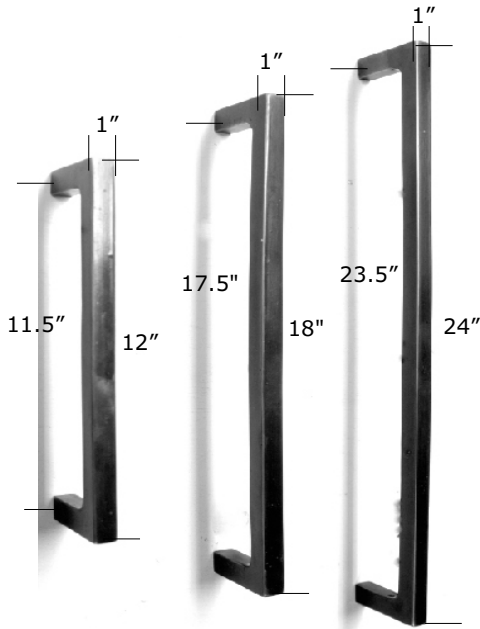

BP779AP-12 BP779AP-18 BP779AP-24

Stockholm Pulls

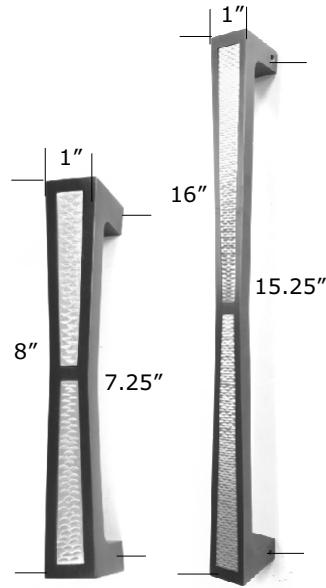

BPG811AP-8 BPG811AP-16

Grande Manhattan Pulls

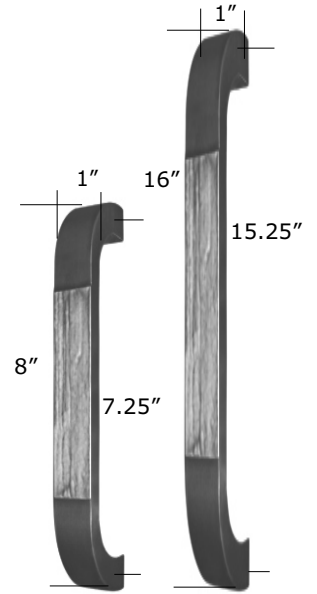

BP814AP-8 BP814AP-16

Amalfi Pulls

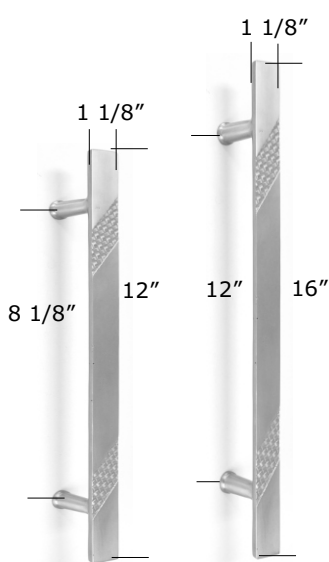

BP816AP-12 BP816AP-16

Amora Pulls

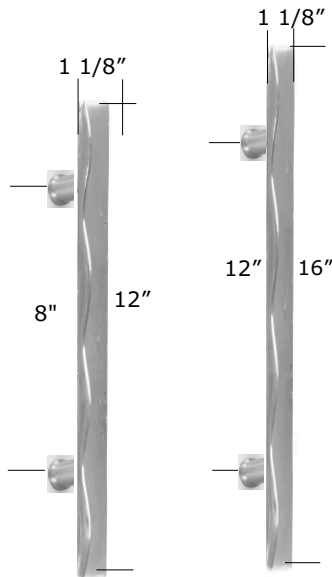

BP818AP-12 BP818AP-16

Cayman Pulls

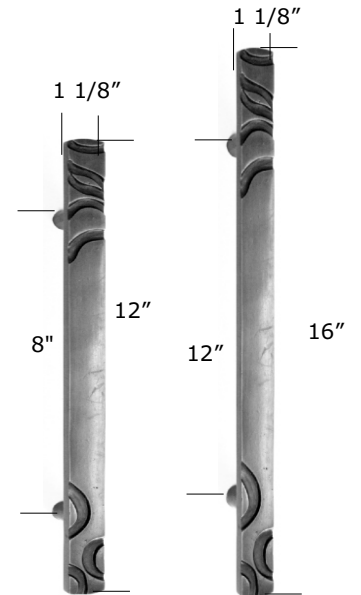

BP822AP-12 BP822AP-16

Aria Pulls

(2" projection on all of these pulls)

All rights reserved. Rev 0118



SOLID BRONZE INTERIOR DOOR HARDWARE

DOOR/ APPLIANCE PULLS & PUSH PLATES

AVAILABLE FOR FRONT-MOUNT OR BACK-TO-BACK MOUNTING (specify door thickness)

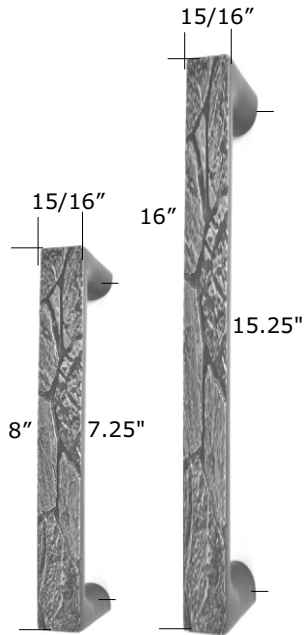

BP820AP-8 BP820AP-16
Canyon Pulls

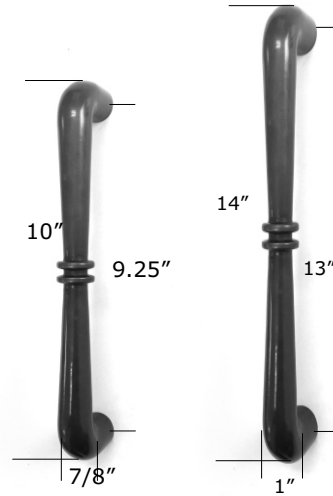

BP824AP-10 BP824AP-14
Fleur de Lis Pulls

(2" projection for all of these pulls)

PUSH PLATES

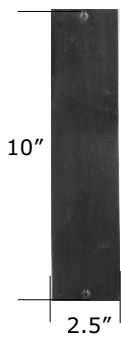

BE715 Straight Edge
BE715B Beveled



BE616 Straight Edge
BE616B Beveled

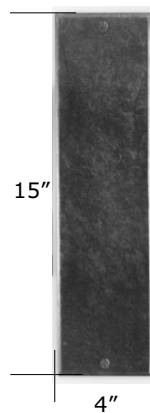

BE617B Beveled

All rights reserved. Rev 0118



CONTENTS

This section contains hinges, door accessories, window hardware, and miscellaneous accessories.

Straps & Braces	Page 8-1
Door Knockers, Surface Bolts, Clavos	Page 8-2
Door Stops	Page 8-3
Window Hardware	Page 8-4
Solid Butt Hinges	Page 8-5
Switch Plate Covers	Page 8-6
Door Bell Buttons	Page 8-7
Hook-and-Eye	Page 8-7
Speakeasy Grille	Page 8-7



BB351 Single Arm Brace

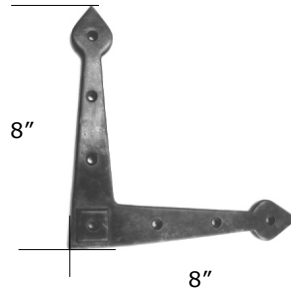

BB355 Corner Brace

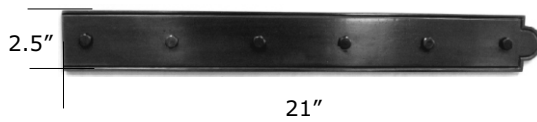

BB800 21" Arch Strap

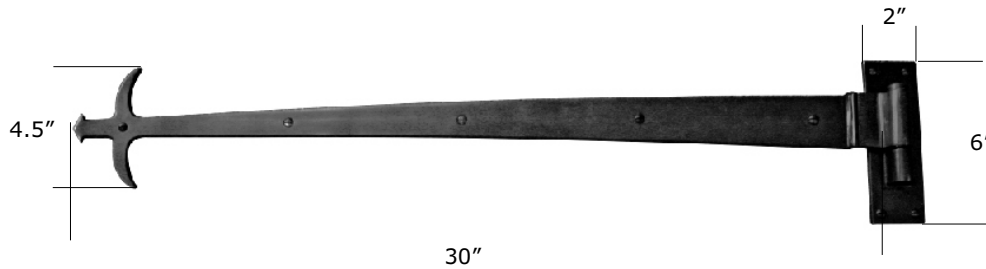

BB812 30" Chateau Pintle Hinge Strap (HANDED, showing LH)

DOOR HANDING GUIDE:

Door Handing is determined by standing at the outside of the door while facing the door. The side of the hinges determines door handing.

Regular In-swing Doors



Out-swing Doors



All rights reserved. Rev 1014



DOOR KNOCKERS

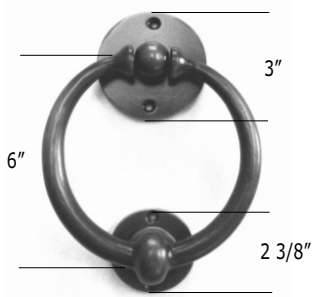

BD254 Ring

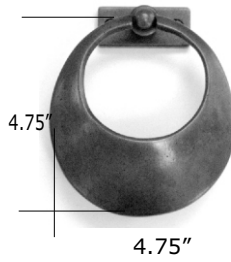

BD256 East-West

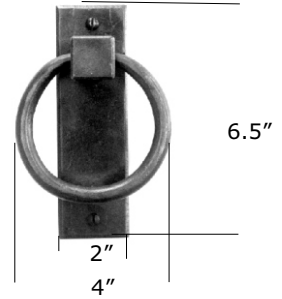

BD257 East-West II

SURFACE BOLTS (With mortise strike. Surface strike available)

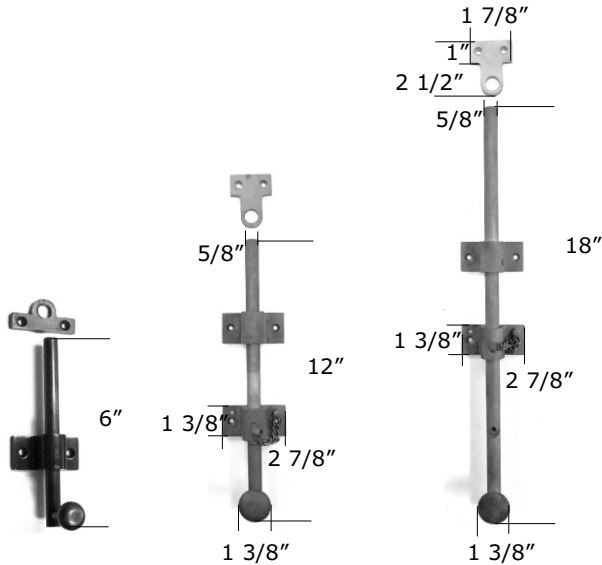

Knob Grip Surface Bolts

- BB283 6" Surface Bolt (1 guide)
- BB285 12" Surface Bolt (2 guides)
- BB287 18" Surface Bolt (2 guides)
- BB288 24" Surface Bolt (3 guides)

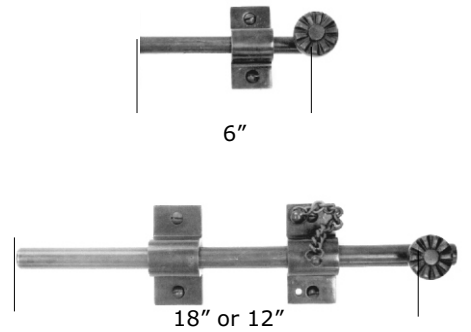

Rosette Grip Surface Bolts

- BB290-6 6" Surface Bolt (1 guide)
- BB290-12 12" Surface Bolt (2 guides)
- BB290-18 18" Surface Bolt (2 guides)
- BB290-24 24" Surface Bolt (3 guides)

CLAVOS

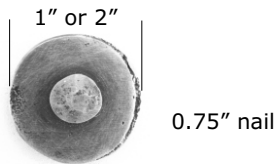

BC332 1" Round
BC333 2" Round

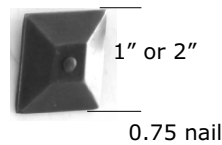

BC352 1" Pyramid
BC353 2" Pyramid

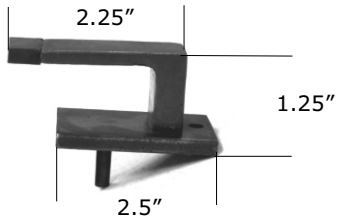

BD258 Contemporary Floor Stop

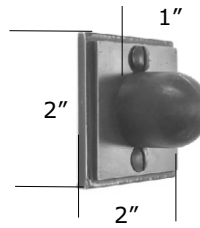

BD259 Wall Stop

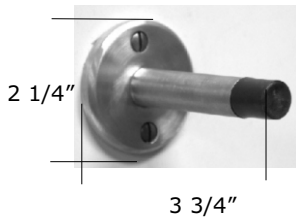

BD261 Base Stop

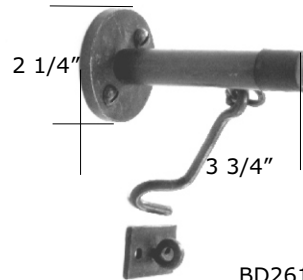

BD261W Base Stop with Hook

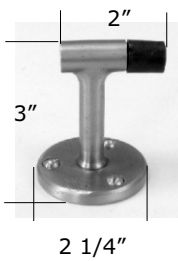

BD262 Floor Stop

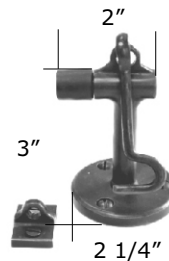

BD262W Floor Stop with Hook



EUROPEAN TILT & PUSH WINDOW HARDWARE

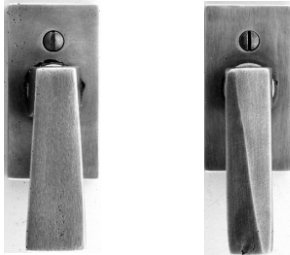

BE620-BL132M

BE620-BL137M

BE620 1.5"x 3" Tilt & Push Escutcheon

Available with:

- BL131M Mini Accent Lever
- BL132M Mini Manhattan Lever
- BL121M Mini Verona Lever
- BL137M Mini Milan Lever
- HL138M Mini Del Mar Levers

WE CAN MAKE ANY OF OUR LEVERS FOR WINDOWS

DOUBLE HUNG WINDOW HARDWARE

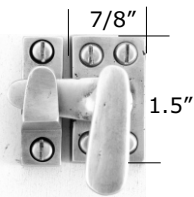

BW114 Sash Lock
SPECIFY Handing (RH shown)

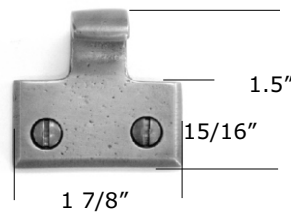

BW117 Sash Lift

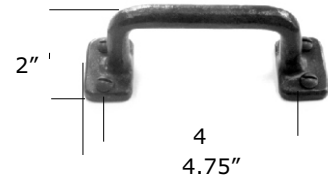

BW112 Front-mount Classic Sash Pull

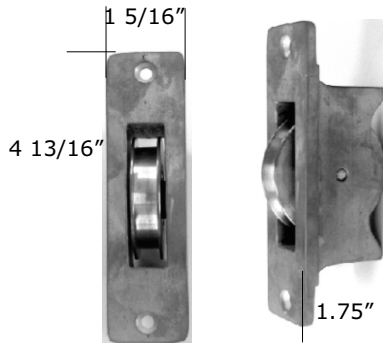

BW210 Window SASH PULLEY
(with #25 natural bronze chain)

CASEMENT WINDOW HARDWARE

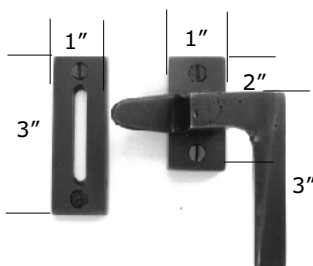

BW116 Milan Window CASEMENT LATCH
(RH shown - SPECIFY HANDING!)

(with standard Mortise Strike as shown)
SPECIFY SURFACE STRIKE if needed!



SILICON BRONZE HEAVY DUTY BUTT HINGES
(WITH TEFLON BUSHINGS)

- * Hinge leaf thickness: 0.1875"
- * Hinge barrel diameter: 0.875"
- * Price includes finial

SPECIFY CAP OR BALL FINIAL

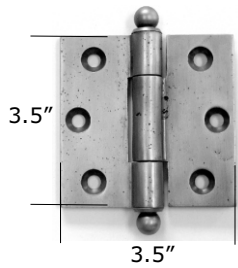

BN403

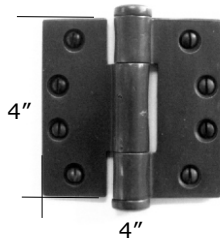

BN406

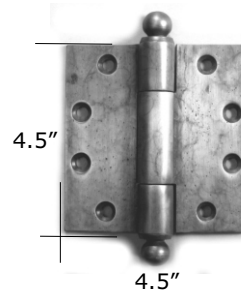

BN405

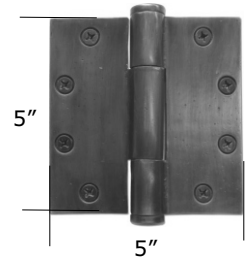

BN407

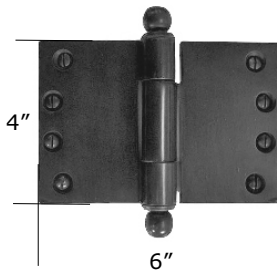

BN408 Wide Throw

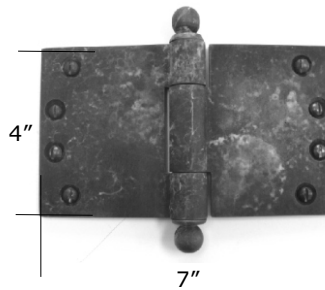

BN409 Wide Throw

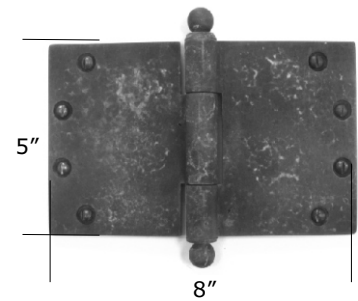

BN410 Wide Throw



DECORA SWITCH & RECEPTACLE COVERS

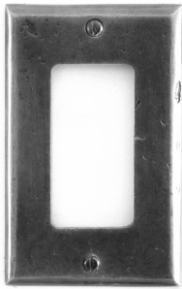

BSP1 shown

BSP1: Single Decora 2.75" x 4 9/16"

BSP2: Double Decora 4 9/16" x 4 9/16"

BSP3: Triple Decora 6 7/16" x 4 9/16"

BSP4: Quad Decora 8.25" x 4 9/16"

BSPP: Cover Plate 2.75" x 4 9/16"

OUTLET COVERS

BOP1: 2.75" x 4 9/16"



SOLID BRONZE ACCESSORIES

DOOR BELL BUTTONS, MISCELLANEOUS ACCESSORIES

DOOR BELL BUTTONS (ANY ESCUTCHEON CAN BE MADE INTO A DOOR BELL BUTTON)

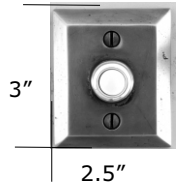

BE602-BB

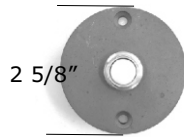

BE606L-BB

BE602-BB: 2.5"x3" Beveled Escutcheon

BE606L-BB: 3" Round Escutcheon

BE607L-BB: 2 5/8" Square Straight Edge Escutcheon

BE621NS-BB: 2" x 3" Notched Escutcheon

BE644-BB: 2" x 3" Straight Edge Escutcheon

BE645-BB: 2 5/8" Art Nouveau Escutcheon

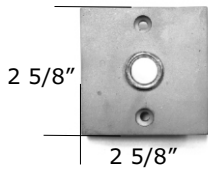

BE607L-BB

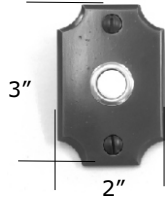

BE621NS-BB

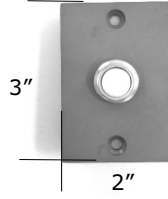

BE644-BB



BE645-BB

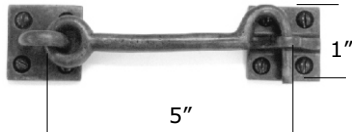

BB370S-5 Hook & Eye
BB370S-8 Hook & Eye
BB370S-10 Hook & Eye
(1.5" PROJECTION)

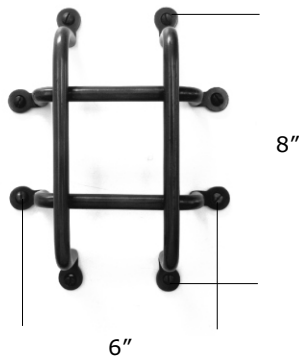
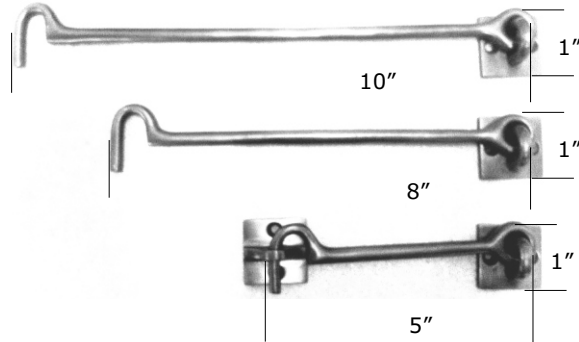

BG281 Speakeasy Grille

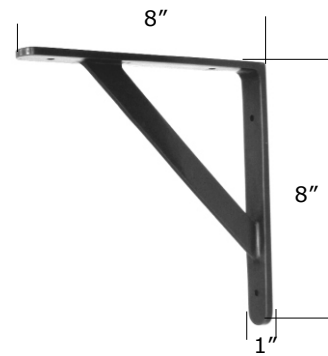

BSB122 Shelf Bracket

All rights reserved. Rev 0118



CONTENTS

This section contains kitchen and bath hardware

Cabinet Pulls & Knobs

Page 9-1 / 9-6

Bath Hardware

Page 9-7 / 9-8

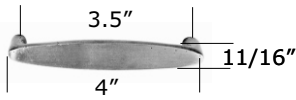

BP707SC-4 El Secreto

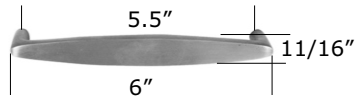

BP707SC-6 El Secreto



BP707SC-8 El Secreto



BP707SC-12 El Secreto

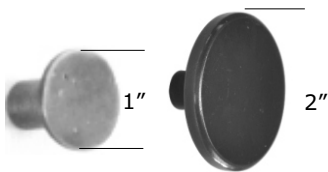

BP731 1" Round
BP732 2" Round

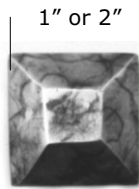

BP733 1" Pyramid
BP734 2" Pyramid

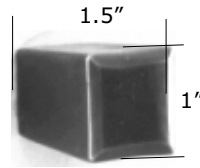

BP735 East-West

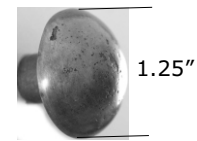

BP739 Mushroom

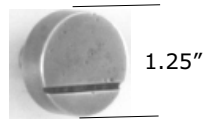

BP740 Sunrise



BP736 Rectangular



BP726-8 Rectangular



BP726-12 Rectangular



BP726-20 Rectangular

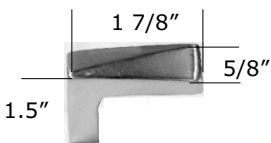

BP737 L-shaped Milan

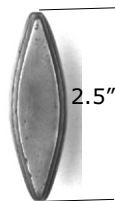

BP741 Art Deco Oval



BP742 Art Deco Round

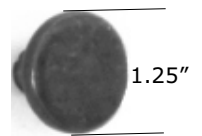

BP743 Martini

NOTE: MOST CABINET PULLS HAVE A 1 1/8" - 1 1/4" PROJECTION

All rights reserved. Rev 0118

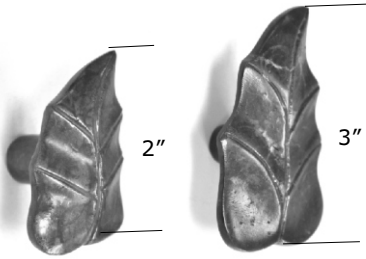

BP744: 2" Leaf BP746" 3" Leaf



BP745 Casa California

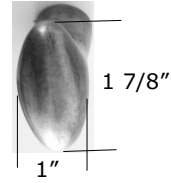

BP747 Eagle Eye



BP749 Whale tail

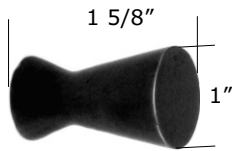

BP751 Aegean

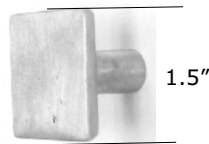

BP752 Scottsdale Square

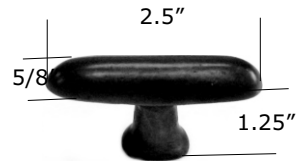

BP753 Oblong

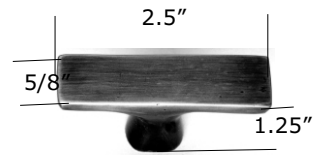

BP754 Scottsdale T-knob



BP754M Scottsdale

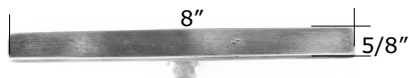

BP754L-8 Scottsdale 8" Single Post

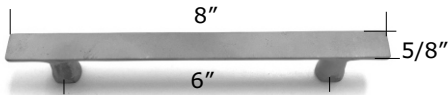

BP754DL-8 Scottsdale 8" Double Post

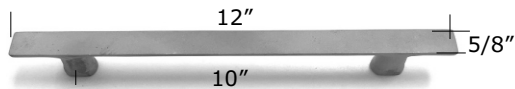

BP754DL-12 Scottsdale 12" Double Post

NOTE: MOST CABINET PULLS HAVE A 1 1/8" - 1 1/4" PROJECTION

All rights reserved. Rev 0118

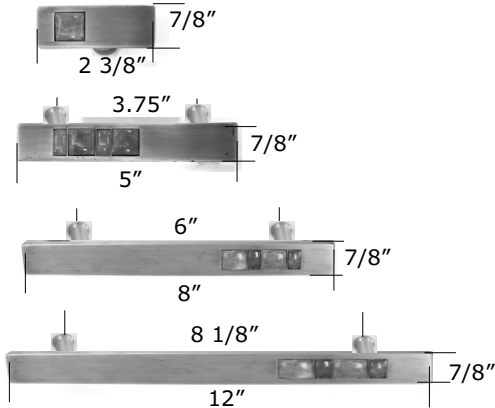

BPR754 Scottsdale Royale T-knob

BPR754-M Scottsdale Royale

BPR754DL-8 Scottsdale Royale

BPR754DL-12 Scottsdale Royale

AVAILABLE IN TWO STONE COMBINATIONS: Turquoise/ Dark Rotile & Green/ Yellow Opals. Call us for custom options

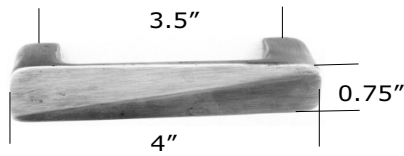

BP756 Milan Large

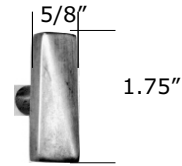

BP774 Milan Rectangular

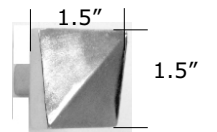

BP775 Milan Square



BP756N-4 Milan

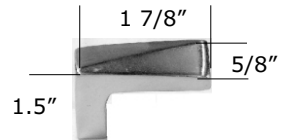

BP737 L-shaped Milan

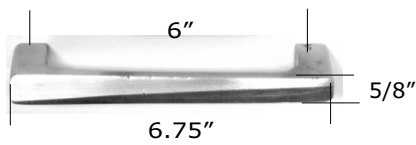

BP756N-6 Milan

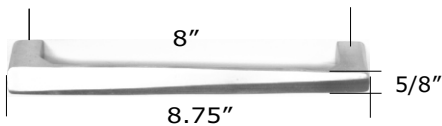

BP756N-8 Milan

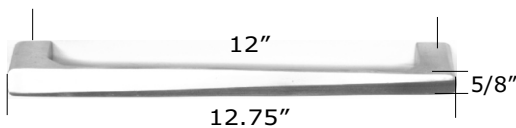

BP756N-12 Milan

NOTE: MOST CABINET PULLS HAVE A 1 1/8" - 1 1/4" PROJECTION

All rights reserved. Rev 0118



BP761 Melon Large

2.25"

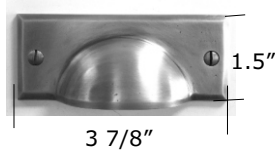

BP762 Bin Pull

3 7/8"

1.5"

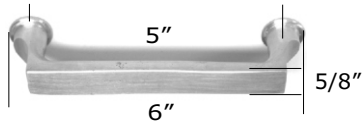

BP772-6 Prescott

5"

5/8"

6"

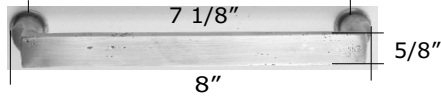

BP772-8 Prescott

7 1/8"

5/8"

8"

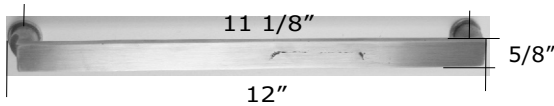

BP772-12 Prescott

11 1/8"

5/8"

12"

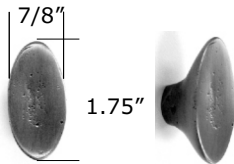

BP781 Ellipse

7/8"

1.75"

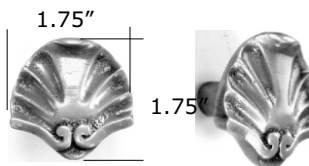

BP782 Seashell

1.75"

1.75"

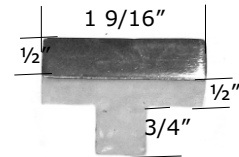

BP780 Stockholm T-knob

1 9/16"

1/2"

1/2"

3/4"



Stockholm Cabinet Pull

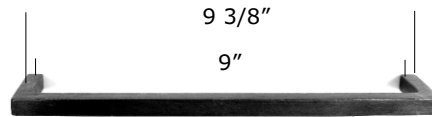

9 3/8"

9"

(3/8" square profile. BP779-9 shown)

- BP779-4: 4 3/8" total length, 4" c-to-c
- BP779-6: 6 3/8" total length, 6" c-to-c
- BP779-9: 9 3/8" total length, 9" c-to-c
- BP779-12: 12 3/8" total length, 12" c-to-c
- BP779-15: 15 3/8" total length, 15" c-to-c
- BP779-24: 24 3/8" total length, 24" c-to-c

NOTE: MOST CABINET PULLS HAVE A 1 1/8" - 1 1/4" PROJECTION

All rights reserved. Rev 0118

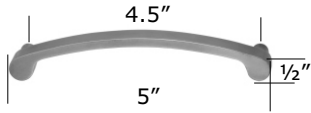

BP785-5 Soho

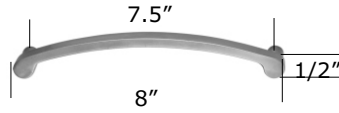

BP785-8 Soho



BP811-5 Manhattan
(no inlay)



BP811-8 Manhattan
(no inlay)

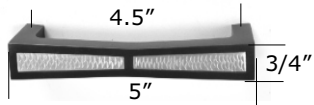

BPG811-5 Grande Manhattan
(w/ inlay)

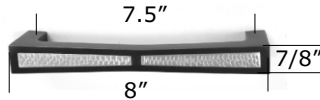

BPG811-8 Grande Manhattan
(w/ inlay)



BP814-5 Amalfi
(no texture)

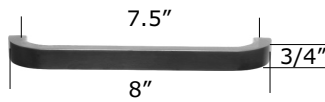

BP814-8 Amalfi
(no texture)

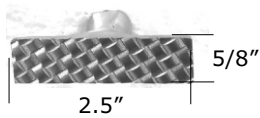

BP816 Amora T-knob

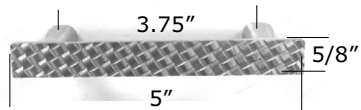

BP816-5 Amora

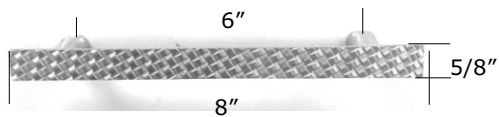

BP816-8 Amora

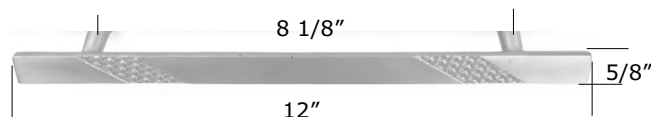

BP816-12 Amora (part textured)

NOTE: MOST CABINET PULLS HAVE A 1 1/8" - 1 1/4" PROJECTION

All rights reserved. Rev 0118

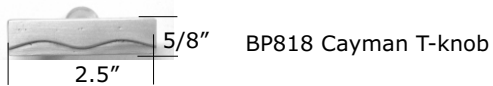

BP818 Cayman T-knob

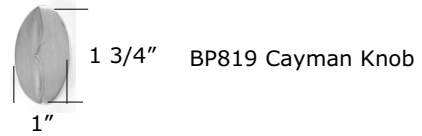

BP819 Cayman Knob

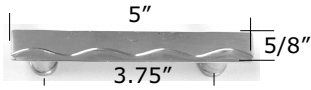

BP818-5 Cayman

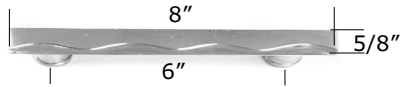

BP818-8 Cayman

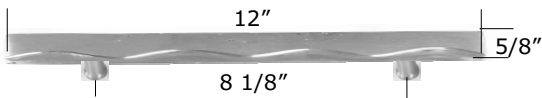

BP818-12 Cayman



BP822 Aria T-knob

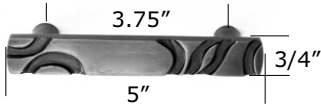

BP822-5 Aria

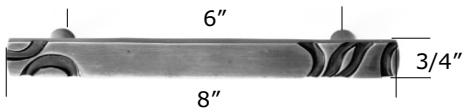

BP822-8 Aria

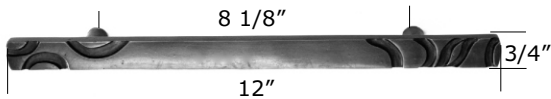

BP822-12 Aria



BP824-5 Fleur de Lis Cabinet Pull



BP824-8 Fleur de Lis Cabinet Pull

NOTE: MOST CABINET PULLS HAVE A 1 1/8" - 1 1/4" PROJECTION

All rights reserved. Rev 0118



ROBE HOOKS

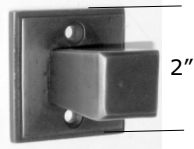

BT702 East-West



BT703 Casa California

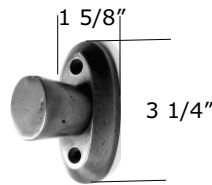

BT704 Oval

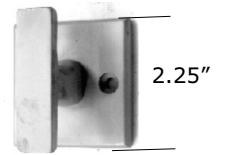

BT705 Scottsdale

TOILET PAPER HOLDERS

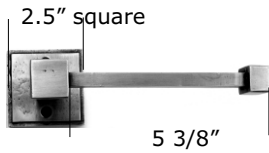

BT711 East-West

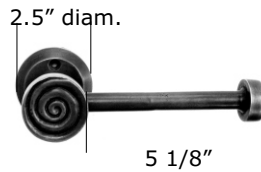

BT712 Casa California

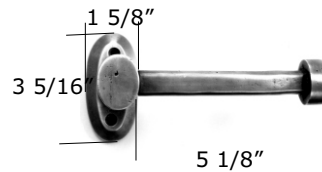

BT713 Oval

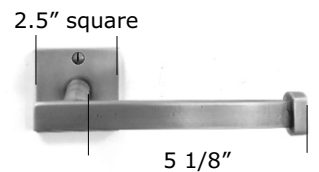

BT715 Scottsdale

TOWEL RINGS

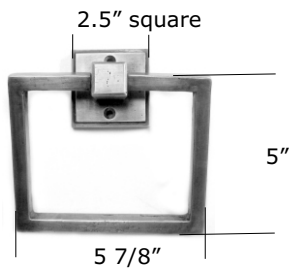

BT746 East-West

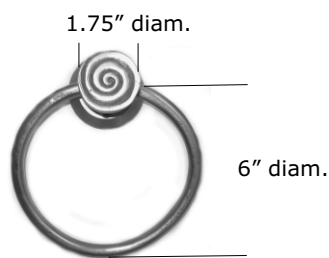

BT747 Casa California

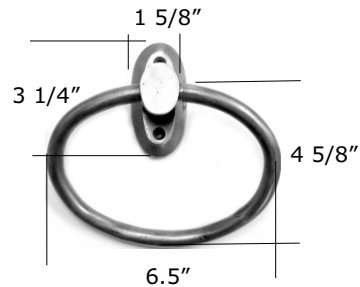

BT748 Oval

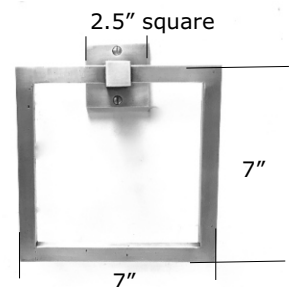

BT745 Scottsdale



TOWEL BARS

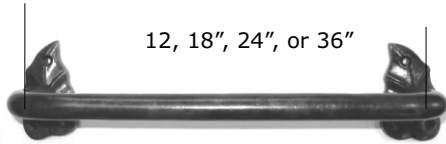

Leaf Continuous Towel Bar

- 12": BT612
- 18": BT618
- 24": BT624
- 36": BT636

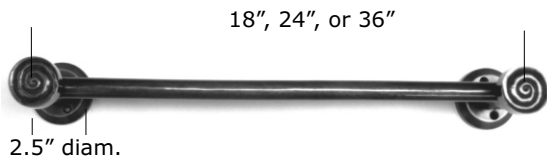

Casa California Towel Bar

- 18": BT718
- 24": BT724
- 36": BT726



East-West Towel Bar

- 18": BT736
- 24": BT737
- 36": BT738

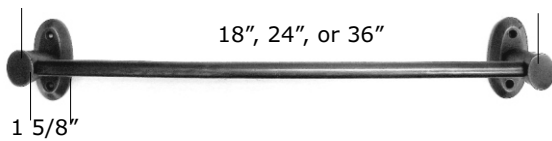

Oval Towel Bar

- 18": BT751
- 24": BT752
- 36": BT753



Scottsdale Towel Bar

- 18": BT755
- 24": BT756



SOLID BRONZE HOSPITALITY
KEYLESS ENTRIES

AVAILABLE FOR VING CARD & SAFLOK SYSTEMS. FULLY CUSTOMIZABLE. CALL US TO INQUIRE!

EXTERIOR SIDE



BE-403 Escutcheon shown with BL-132 Lever

MT LOCK: BE-403 3 3/8" X 10" Rectangular Escutcheon

FOR OTHER KEYLESS STYLES PLEASE ENQUIRE WITH US

FOR QUALIFYING HOSPITALITY PROJECTS,
CUSTOM DESIGNS MAY BE AVAILABLE WITHOUT AN UPCHARGE.
CALL US FOR ASSISTANCE!

All rights reserved. Rev 1014